

# Fibre-optic sensors and cables

Fibre-optic sensors and fibre-optic cables for a wide range of applications

## FL 20

from Page 534

- Fibre-optic sensor in miniature housing for installation in restricted spaces
- Simple and reliable mounting of fibre-optic cables via clamping bracket

## FL 70

from Page 538

- High-end fibre-optic sensor with 4-digit display
- Cuboid housing for DIN-rail mounting
- PNP, NPN or analogue output options
- Communication prevents mutual interference

## FMS 18/FMS 30

from Page 544

- Fibre-optic sensors in robust full-metal housings for harsh operating conditions
- Large selection of robust fibre-optic cables
- PNP, NPN or analogue output options

## Fibre-optic cables – standard

from Page 554

- Wide range of photoelectric sensor and diffuse sensor variants
- Fibre-optic cables with lateral light exit for restricted spaces
- Diffuse sensors and photoelectric through-beam sensors with long ranges
- Robust fibre and sheath materials for harsh operating conditions



Fibre-optic cable systems from SensoPart are the solution when installation space is restricted or operating conditions are hot or dirty. Robust sheath and fibre materials in the fibre-optic cable also offer excellent protection against aggressive chemicals. The sensors are protected in a switching cabinet or at a safe distance, while the fibre-optic cable heads are mounted in the immediate vicinity of the target objects. The large selection of different cable heads opens up numerous application possibilities for our customers as well as providing a high level of flexibility regarding mounting.

Some fibre-optic cable systems from SensoPart cover the same applications as conventional optical sensors. Depending on the customer's application, they are available as photoelectric sensors or diffuse sensors. Whereby the powerful fibre-optic sensors ensure high levels of functionality and reliability.

High flexibility and low weight on the gripper of a robot, aggressive detergents in the pharmaceutical or food industries, red-hot objects, minimal light spot dimensions for the detection of small parts, strip edge control, or the detection of liquids and levels in pipes and vessels – high-quality fibre-optic cable systems from SensoPart are predestined for use in all these applications.

Applications in which differing detection tasks have to be carried out in the smallest of spaces often pose the risk of mutual interference. This can lead to unwanted spurious switching. No problem for the FL 70 series: it has a communication interface that ensures that several FL 70 sensors can be synchronised and always switch correctly. The communication takes place fully automatically after battery installation, without any additional adjustment effort for customers. In other words, extremely simple installation and precise detection in the smallest of spaces.

**Fibre-optic cables –  
focused optics**  
from Page 598

- Precise, small light spot for small-part detection
- Adjustable scanning distance and light spot size



**Fibre-optic cables –  
light strips**  
from Page 604

- Photoelectric sensor and diffuse sensor variants
- Variety of light strip widths and ranges



**Fibre-optic cables –  
special**  
from Page 612

- Bendable fibre-optic cable tips for particularly restricted installation conditions
- Prism scanner for filling level measurement
- V-scanner for small objects or liquid and level measurements
- Fork sensors in small housings



**Fibre-optic cables –  
accessories**  
from Page 624

- Fibre-optic cable by the metre
- Ancillary lenses for extending ranges
- Cutting tool for shortening and bending fibre-optic cables



TYPICAL SENSOPART

- Sub-miniature FL 20 housing for simple integration in machines
- Powerful & variable FL 70 fibre-optic cable sensors
- FMS serie: powerful sensors for extreme demands
- Wide range of fibre-optic cables for standard applications or individual customer requirements
- Numerous adjustment possibilities: stable or dynamic teach-in, external control line, accuracy and speed adjustment, timing functions
- Intelligent fibre-optic sensor and cable mounting solutions for easy installation and adjustment
- Reliable operation without mutual interference thanks to communication between FL 70 devices

# Fibre-optic cable sensors

## System description

### How fibre-optic cables function

Light guidance is based on the physical effect of total reflection, whereby light coupled into a glass fibre is repeatedly reflected back into the glass fibre from the boundary surface. The major advantage of this technology is that the light can be transported over long distances with almost no loss.

Fibre-optic sensors use this principle to bring the transmitted light to an inaccessible location and take up the reflected light again to return it to the sensor, mounted where more space is available. This technology, which can also be used for the detection of very small objects, is characterised by precision and reliability.

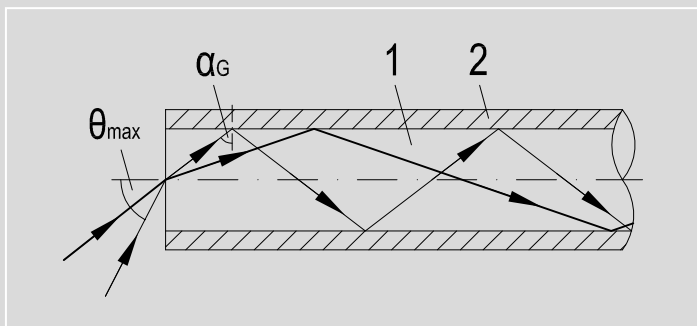

### Light guidance in fibre-optic cable

The light is transported in the fibre-optic cable in an axial direction as a result of total reflection at the boundary surface between the sheath (2) and the core (1). The size of the limit angle of the total reflection ( $\alpha_G$ ) defines the acceptance angle of the fibre-optic cable ( $\theta_{max}$ ). Light hitting the face of the fibre at this or a smaller angle is transported in the fibre-optic cable.

### Fibre-optic cable materials



Fibre-optic cables differ in the transmission material used – glass or plastic. SensoPart offers the so-called fibre material in both variants. Glass fibres are highly resistant to chemicals and high temperatures. Suitable metal or silicone sheath materials allow the use of glass fibres in harsh environmental and process conditions. Larger glass-fibre cross-sections offer high functional reserves and reliability, even in dusty and dirty environments.

### Fibre-optic cables as photoelectric through-beam sensors

The transmission and receiver fibre-optic cables of photoelectric through-beam sensors run in two separate fibre-optic cables. Both fibre-optic cables are optically connected to the sensor via a coupling. Whereby one fibre-optic cable transports the transmission light from the sensor to the detection location while the other, opposite, fibre-optic cable transports the light back to the receiver. The sensor switches if the light path between the two facing fibre-optic cable heads is interrupted by an object. Relatively long ranges are achieved with photoelectric through-beam sensors.

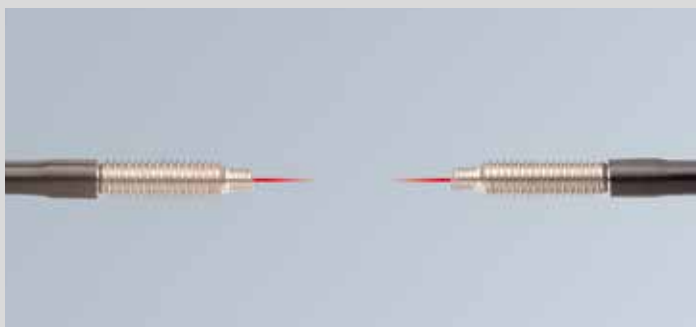

### The photoelectric sensor type

Transmitter cables and receiver cables are laid in two separate sheaths and are connected to the appropriate optical component of the sensor via a coupling.



# FL 20 – sensor for plastic fibre-optic cable adaptation

Small, compact amplifier



 made in Germany

## TYPICAL FL 20



### Fibre assembly / mounting

- Simple exchange of the fibre-optic cables even in mounted state
- No tool necessary
- Secure clamping:
  1. Open clamping bracket
  2. Feed fibre-optic cables into the holder until you reach the stop (get past the resistance from the O-ring)
  3. Close clamping bracket

- Miniature housing 32 x 20 x 12 mm for simple integration in machines
- Teach-in with button or control input
- Dynamic adjustment possible
- High switching frequency
- Red light, 660 nm
- N.O./N.C. switchable
- For fibre-optic cables with diameter of 2.2 mm
- Wide range of adaptable fibre-optic cables

The FL 20 fibre-optic sensor impresses with its small dimensions and convincing performance data. It covers all the requirements of opto-sensors under restricted space conditions and offers highly precise detection with simple handling.

Simple adjustment via teach-in or the control input and its robust metal plug design confirm the uncompromising industrial suitability of the FL 20 fibre-optic sensor.

A broad portfolio of fibre-optic cables with differing heads and a variety of sheath materials solves all tasks precisely and reliably.

FL 20 – Product Overview			
	Type of light	Special features	Page
FL 20	LED, red	Small housing, simple adjustment	536

# FL 20 R

## Fibre-optic sensor



### PRODUCT HIGHLIGHTS

- Simple teach-in via button
- Control line for teach-in and button lock
- Contamination indicator
- N.O./N.C. switchable
- For fibre-optic cables with diameter of 2.2 mm

Optical data		Functions	
Scanning distance	Dependant on fibre-optic cable (scanner) <sup>1</sup>	Indicator LED, green	Stability indicator
Operating range	Dependant on fibre-optic cable (cabinet)	Indicator LED, yellow	Light reception indicator
Type of light	LED, red, 660 nm	Sensor adjustment <sup>2</sup>	Via Teach-in button and control input
Distance hysteresis	< 10 % of set scanning distance	Adjustment possibilities	Button lock via control input
		Default setting	N.O.
Functions		Mechanical data	
Operating voltage, +U <sub>B</sub>	10 ... 30V DC	Dimensions	32 x 20 x 12 mm
Current consumption without load	≤ 25 mA	Enclosure rating	IP 67 <sup>3</sup>
Output current, I <sub>e</sub>	100 mA	Material, housing	ABS
Protective circuits	Reverse-polarity protection, U <sub>B</sub> / short-circuit protection (Q)	Type of connection	See selection table
Protection Class	2	Ambient temperature: operation	-20 ... +60 °C
Switching output, Q	PNP/NPN (see selection table)	Ambient temperature: storage	-20 ... +80 °C
Output function	N.O.	Weight (plug device)	10 g
Switching frequency, f (ti/tp 1:1)	1000 Hz	Weight (cable device)	40 g
Control input, I <sub>N</sub> : (only 4-pin version)	+U <sub>B</sub> = teach-in -U <sub>B</sub> = button locked Open = normal operation		

<sup>1</sup> Reference material: white, 90 % reflectivity    <sup>2</sup> Only 4-pin version    <sup>3</sup> With suitable fibre-optic cable

Switching output	Type of connection	Part number	Article number
PNP	Plug, M8x1, 4-pin	FL 20 R-PSM4	551-71000
PNP	Cable, 2 m, 4-wire	FL 20 R-PSK4	551-71001
NPN	Plug, M8x1, 4-pin	FL 20 R-NSM4	551-71002
NPN	Cable, 2 m, 4-wire	FL 20 R-NSK4	551-71003
PNP	Plug, M8x1, 3-pin	FL 20 R-PSM3	551-71004

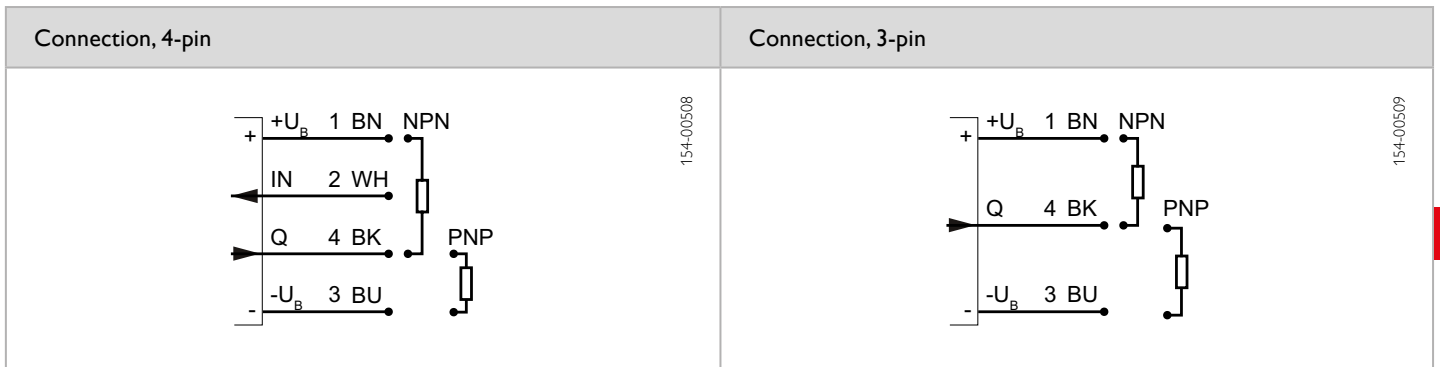
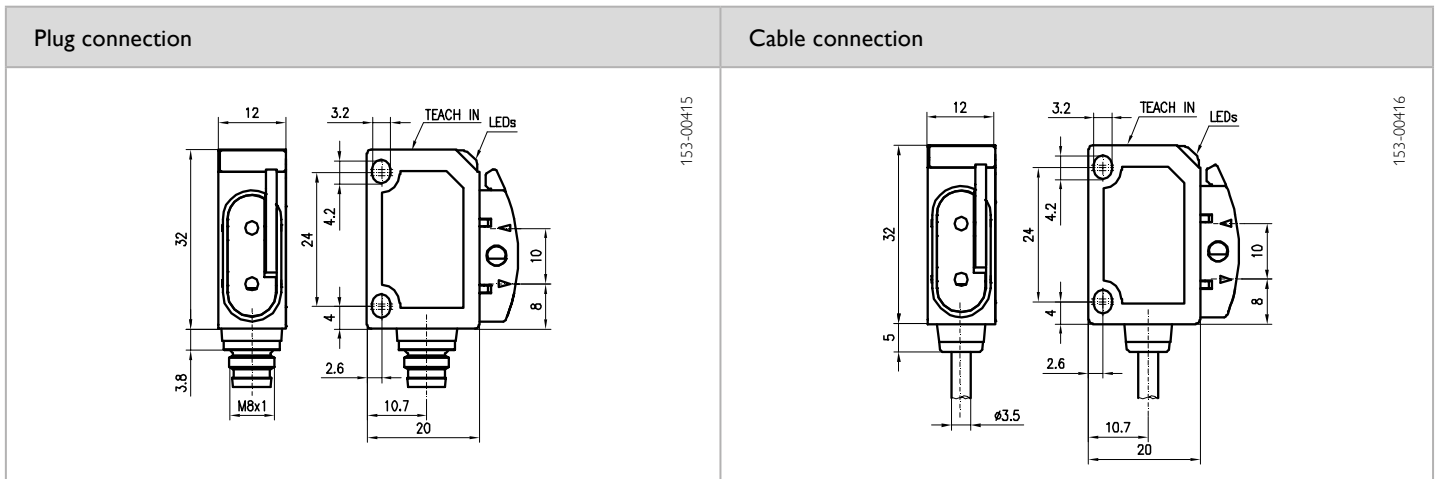

Accessories	
Connection cables	From Page A-46
Brackets	From Page A-4
Fibre-optic cables	From Page 554



# FL 70 – sensors for plastic fibre-optic cable adaptation

Functional DIN-rail devices



 made in Germany



 LOC = lock function – reliably secures against deliberate or accidental tampering

 ADJ = adjustment – the sensor is in setup mode

 SP1 = switching window 1 – window 1 has been taught-in



### Monitoring accumulations with fibre-optic cables

Small plastic plugs are fed in on a vibration conveyor and individualised on a conveyor section. The monitoring of accumulations is carried out with an FL 70 R-PSD fibre-optic sensor in combination with SensoPart's K2L-34 plastic fibre-optic cable. The FL 70 R-PSD sensor is installed in a switching cabinet here. This is not strictly necessary because mounting directly on the machine would have been possible thanks to the robust housing and high enclosure rating of IP 64.

### TYPICAL FL 70

- Very user-friendly teach-in
- High level of accuracy
- High switching frequency
- No mutual interference thanks to automatic optical communication during battery installation
- DIN-rail mounting
- Robust enclosure rating of IP 64
- Wide range of fibre-optic cables

### FL 70 R



The FL 70 R variant manages without a display and is the more economical alternative for standard applications. All variants offer simple operation via teach-in, which is achieved by button or via the teach-in line. The buttons can be locked via the external teach-in line.

### FL 70 R-...D

The FL 70 R-...D is the high-end fibre-optic device with a 4-character display. It is characterised by simple setting and many supplementary functions, e.g. fine adjustment of the switching point, inversion of the switching output, accuracy and speed adaptation, window programming, timer functions and reliable tamper-proofing. The display is always easy to read because it can be rotated through 180°.

### FL 70 RA-...D

The FL 70 RA-...D has a supplementary analogue output which is a major advantage for complex applications, in particular, such as connecting a so-called cross-section converter. This allows, for example, edge control and inspections on the basis of object size.

FL 70 – Product Overview			
	Type of light	Special features	Page
FL 70 R	LED, red	Teach-in	540
FL 70 R-...D	LED, red	Teach-in, display 	542
FL 70 RA-...D	LED, red	Teach-in, display, analogue output 	542

# FL 70 R

## Fibre-optic sensor



### PRODUCT HIGHLIGHTS

- Fibre-optic sensor for the adaptation of a wide variety of fibre-optic cables
- DIN-rail mounting
- No mutual interference thanks to automatic communication
- Simple operation via electronic Teach-in button or control line
- Robust plastic housing (IP 64)

Optical data		Functions	
Scanning distance	Dependant on fibre-optic cable (scanner) <sup>1</sup>	Indicator LED, green	Operating voltage indicator
Operating range	Dependant on fibre-optic cable (cabinet)	Indicator LED, yellow	Switching output indicator
Type of light	LED, red, 630 nm	Scanning distance adjustment	Via Teach-in button and control input
Distance hysteresis	< 10 % of set scanning distance	Adjustment possibilities	Button lock via control input; N.O./N.C.
		Default setting	N.O.
Functions		Mechanical data	
Operating voltage, +U <sub>B</sub>	10 ... 30V DC <sup>2</sup>	Dimensions	84 x 35 x 10 mm
No-load current, I <sub>0</sub>	≤ 20 mA	Enclosure rating	IP 64 <sup>3</sup>
Output current, I <sub>e</sub>	≤ 100 mA	Material, housing	ABS
Protective circuits	Reverse-polarity protection, U <sub>B</sub> / short-circuit protection (Q)	Type of connection	See selection table
Protection Class	2	Ambient temperature: operation	-20 ... +60 °C
Switching output, Q	PNP/NPN (see selection table)	Ambient temperature: storage	-20 ... +80 °C
Output function	N.O./N.C.	Weight (plug device)	20 g
Switching frequency, f (ti/tp 1:1)	≤ 1500 Hz	Weight (cable device)	50 g
Control input, IN (only 4-pin version)	+U <sub>B</sub> = teach-in -U <sub>B</sub> = button locked Open = normal operation		

<sup>1</sup> Reference material: white, 90 % reflectivity    <sup>2</sup> Max. 10 % ripple, within U<sub>B</sub>    <sup>3</sup> With connected IP 64 plug

Switching output	Type of connection	Part number	Article number
PNP	Plug, M8x1, 4-pin	FL 70 R-PS-M4	567-71000
NPN	Plug, M8x1, 4-pin	FL 70 R-NS-M4	567-71001
PNP	Cable, 2 m, 4-wire	FL 70 R-PS-K4	567-71002
NPN	Cable, 2 m, 4-wire	FL 70 R-NS-K4	567-71003

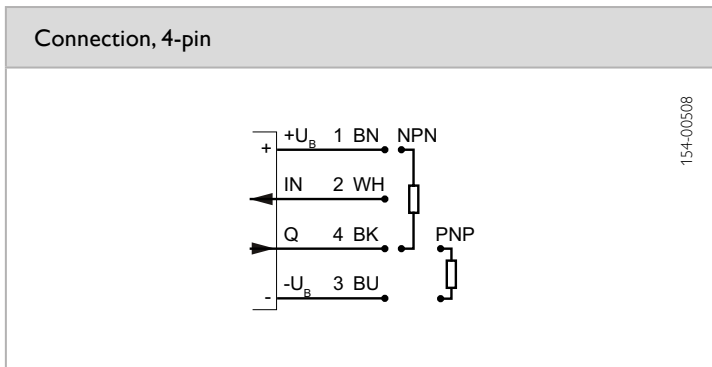
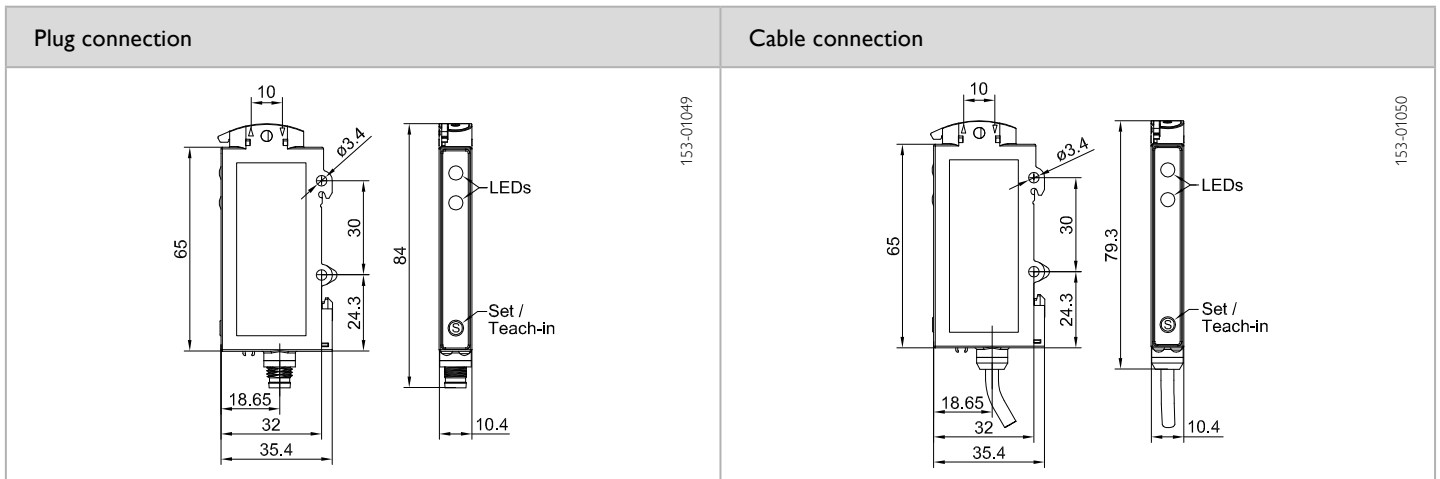

Accessories	
Connection cables	From Page A-46
Brackets	From Page A-4
Fibre-optic cables	From Page 554

# FL 70 R-...D / FL 70 RA-...D

Fibre-optic sensor with display



## PRODUCT HIGHLIGHTS

- Fibre-optic sensor for the adaptation of a wide variety of fibre-optic cables
- Very user-friendly thanks to combination of display and teach-in
- Several operating modes for individual adaptation to the application
- DIN-rail mounting
- No mutual interference thanks to automatic communication
- Variants with supplementary analogue output

Optical data		Functions	
Scanning distance	Dependant on fibre-optic cable (scanner) <sup>1</sup>	Indicator LED, green	Operating voltage indicator
Operating range	Dependant on fibre-optic cable (cabinet)	Indicator LED, yellow	Switching output indicator
Type of light	LED, red, 630 nm	Indicator LEDs, red (x6)	Feedback on selected functions
Distance hysteresis	< 10 % of set scanning distance	Teach-in modes	Switching point / switching window
		Scanning distance adjustment	Fine adjustment of the switching point
		Adjustment possibilities	Via teach-in and control input
			Invert switching output
			Switching frequency / accuracy
			Timer function (e.g. switch-on delay)
			Button lock, default settings
		Default settings	N.O. / no special functions active
Functions		Mechanical data	
Operating voltage, +U <sub>B</sub>	10 ... 30V DC <sup>2</sup>	Dimensions	84 x 35 x 10 mm
No-load current, I <sub>0</sub>	≤ 25 mA	Enclosure rating	IP 64 <sup>3</sup>
Output current, I <sub>e</sub>	≤ 100 mA	Material, housing	ABS
Protective circuits	Reverse-polarity protection, U <sub>B</sub> / short-circuit protection (Q)	Type of connection	See selection table
Protection Class	2	Ambient temperature: operation	-20 ... +60 °C
Switching output, Q	PNP/NPN (see selection table)	Ambient temperature: storage	-20 ... +80 °C
Output function	N.O./N.C.	Weight (plug device)	20 g
Switching frequency, f (ti/tp 1:1)	Dependent on the setting / operating mode Standard Mode 1000 Hz / Fast Mode 8000 Hz Fine Mode 125 Hz / High Distance Mode 125 Hz	Weight (cable device)	50 g
Control input, IN (only 4-pin version)	+ U <sub>B</sub> = teach-in - U <sub>B</sub> = button locked Open = normal operation		
Analogue output (non-scalable)	See selection table		
Display value 0000	0V		
Display value 4095	10V		

<sup>1</sup> Reference material: white, 90 % reflectivity

<sup>2</sup> Max. 10 % ripple, within U<sub>B</sub>

<sup>3</sup> With connected IP 64 plug

Switching output	Analogue output	Type of connection	Part number	Article number
PNP	No	Plug, M8x1, 4-pin	FL 70 R-PSD-M4	567-71004
NPN	No	Plug, M8x1, 4-pin	FL 70 R-NSD-M4	567-71005
PNP	0...10V / 2 mA	Cable, 2 m, 5-wire	FL 70 RA-PSD-K5	567-71006
NPN	0...10V / 2 mA	Cable, 2 m, 5-wire	FL 70 RA-NSD-K5	567-71007

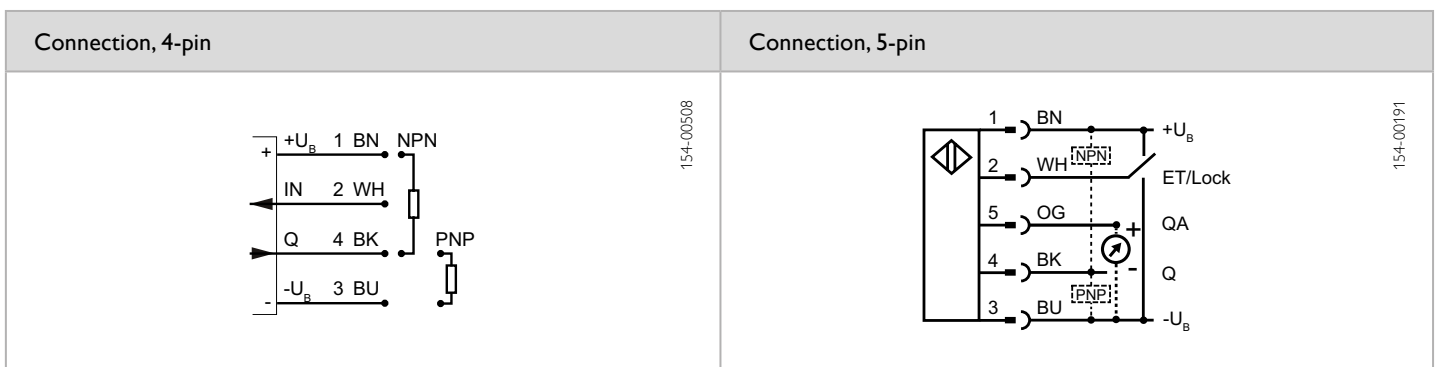
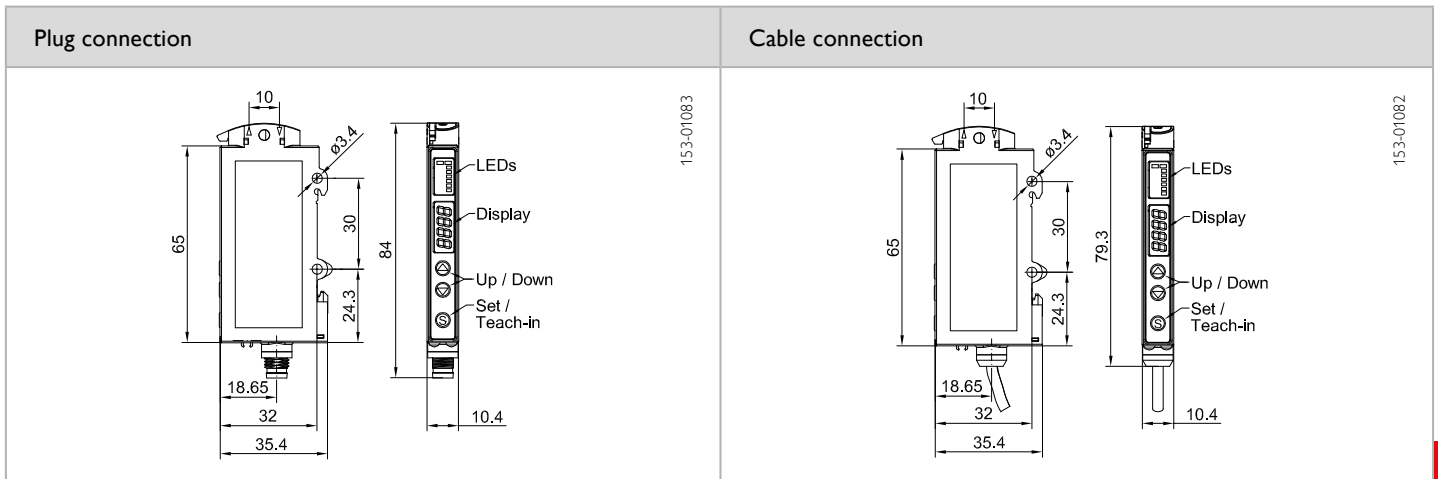

Accessories	
Connection cables	From Page A-46
Brackets	From Page A-4
Fibre-optic cables	From Page 554

# FMS 18 / FMS 30

## sensors for glass fibre adaptation

Robust, strong, reliable



 made in Germany



### Switching of output function and scanning distance

The N.C./N.O. function is set via the sliding switch on the front. The switching position "Sn/2" reduces the scanning distance by 50 % and thus permits improved small-part detection



### Uncomplicated adaptation of fibre-optic cable and amplifier

The glass fibres can be adapted by simply screwing them to the FMS sensors (here the FMS 30).

### TYPICAL FMS 18 / FMS 30

- Operating range: scanner max. 800 mm (depending on the fibre-optic cable used)
- Operating range: photoelectric sensor max. 4800 mm (depending on the fibre-optic cable used)
- Robust metal housings
- Antivalent switching output
- N.O./N.C. switchable
- Various sheaths for glass fibres
- Fibre-optic cables for temperatures up to 160°C
- Resolution/scanning distance switchable
- Cross-section converter adaptable

### FMS 18

The FMS 18-4 U fibre-optic sensor operates at minimum to medium switching distances and ranges. The device is particularly suitable for reliable non-contact detection in rapid processes as a result of its high switching frequency of 1 kHz. Despite the device's small size, its output signal can be inverted by using a plug-in bridge on the front. The sensor also has two separate outputs: P- and N-switching.

A second switch on the front inverts the output signal. The sensor can thus provide the logically correct signal, i.e. N.O. or N.C. depending on the particular application. Every device also has two separate outputs: P- and N-switching.

### FMS 30

The FMS 30-4 U fibre-optic sensor operates throughout the entire range from low to very long switching distances and ranges. The switching distance can be halved by using the switch on the front of the device. This simplifies accurate adjustment of the switching point at close range and improves small-part detection.

FMS 18/ FMS 30 – Product Overview			
	Type of light	Special features	Page
FMS 18	LED infrared, red	Extremely robust	546
FMS 30	LED infrared	Extremely robust, powerful	548



# FMS 18-34 U

Photoelectric diffuse sensor for adaptation of fibre-optic cables



## PRODUCT HIGHLIGHTS

- Scanning distance dependant on fibre-optic cable
- Fibre-optic cable adaptable
- Universal PNP/NPN output
- N.O./N.C. selectable
- M18 metal threaded sleeve

Optical data		Functions	
Scanning distance	See selection table <sup>1</sup>	Indicator LED, green	Operating voltage indicator
Type of light	See selection table	Indicator LED, yellow	Switching output indicator
Distance hysteresis <sup>1</sup>	< 10 % of the set scanning distance	Indicator LED, red	Contamination indicator
		Sensitivity adjustment	Via 18-step potentiometer
Electrical data		Mechanical data	
Operating voltage, +U <sub>B</sub>	10 ... 30V DC <sup>2</sup> / 15 ... 30V DC <sup>3</sup>	Dimensions	See dimensional drawings
No-load current, I <sub>0</sub>	≤ 25 mA	Enclosure rating	IP 65 <sup>5</sup>
Output current, I <sub>e</sub>	≤ 200 mA	Material, housing	Brass, nickel-plated
Pull-up resistance	22 kΩ	Type of connection	See selection table
Pull-down resistance	22 kΩ	Ambient temperature: operation	-20 ... +60 °C
Protective circuits	Reverse-polarity protection, U <sub>B</sub> / short-circuit protection (Q)	Ambient temperature: storage	-40 ... +80 °C
Protection Class	2	Weight (plug device)	85 g
Power On Delay	≤ 300 ms	Weight (cable device)	185 g
Switching output, Q	PNP/NPN	Vibration and impact resistance	EN 60947-5-2
Output function	N.O./N.C.		
Switching frequency, f (ti/tp 1:1)	See selection table <sup>4</sup>		

<sup>1</sup> Reference material: white, 90 % reflectivity    <sup>2</sup> Type of light: infrared 880 nm    <sup>3</sup> 10 % ripple, within U<sub>B</sub>    <sup>4</sup> Type of light: infrared 880 nm with scanning distance of 1 m

<sup>5</sup> With connected IP 65 plug

Scanning distance	Type of light	Switching frequency, f (ti/tp 1:1)	Type of connection	Part number	Article number
500 mm	Infrared, 880 nm	5000 Hz	Plug, M12, 4-pin	FMS 18-34 UL4-60	510-51590
1000 mm	Infrared, 880 nm	1000 Hz	Plug, M12, 4-pin	FMS 18-34 UL4	510-51589
500 mm	Infrared, 880 nm	5000 Hz	Cable, 3 m, 4-wire	FMS 18-34 U-60	510-51588
1000 mm	Infrared, 880 nm	1000 Hz	Cable, 3 m, 4-wire	FMS 18-34 U	510-51587
250 mm	Red, 645 nm	1000 Hz	Plug, M12, 4-pin	FMS 18-34 UL4-52	510-51602
500 mm	Infrared, 950 nm	1000 Hz	Plug, M12, 4-pin	FMS 18-34 UL4-54	510-51605
250 mm	Red, 645 nm	1000 Hz	Cable, 3 m, 4-wire	FMS 18-34 U-52	510-51603
500 mm	Infrared, 950 nm	1000 Hz	Cable, 3 m, 4-wire	FMS 18-34 U-54	510-51604

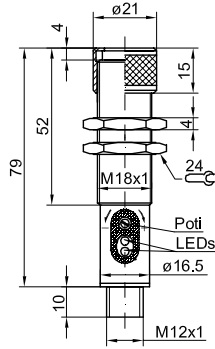
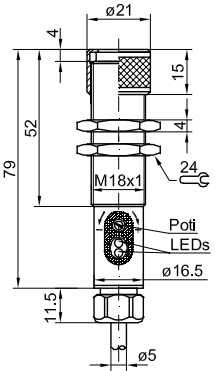
Plug connection	Cable connection
 <p style="text-align: right;">153-00002</p>	 <p style="text-align: right;">153-00001</p>

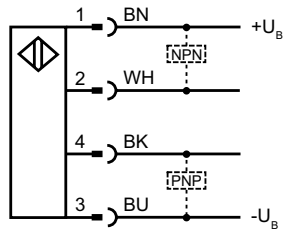
Connection, 4-pin	
 <p style="text-align: right;">154-00282</p>	

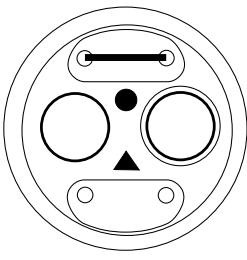
N.O./N.C. function			
Selectable via plug-in bridge on the front	Plug-in bridge	Scanner operation	Through-beam operation
 <p style="text-align: right;">155-00921</p>	●	N.C.	N.O.
	Without plug-in bridge	N.O.	N.C.
	▲	Parking position	Parking position

# FMS 30-44 U

Photoelectric diffuse sensor for adaptation of fibre-optic cables



## PRODUCT HIGHLIGHTS

- Scanning distance dependant on fibre-optic cable
- High switching frequency, 1 kHz, 5 kHz
- Fibre-optic cable adaptable
- Universal PNP/NPN output
- N.O./N.C. selectable
- M30 metal threaded sleeve

Optical data		Functions	
Scanning distance	0.5 m / 1m <sup>1</sup>	Indicator LED, green	Operating voltage indicator
Type of light	Infrared, 880 nm	Indicator LED, yellow	Switching output indicator
Distance hysteresis <sup>1</sup>	< 10 % of the set scanning distance	Indicator LED, red	Contamination indicator
		Sensitivity adjustment	Via 18-step potentiometer
Electrical data		Mechanical data	
Operating voltage, +U <sub>B</sub>	10 ... 30V DC <sup>2</sup>	Dimensions	(See connection diagram)
No-load current, I <sub>0</sub>	≤ 25 mA	Enclosure rating	IP 65 <sup>3</sup>
Output current, I <sub>e</sub>	≤ 200 mA	Material, housing	Brass, nickel-plated
Pull-up resistance	22 kΩ	Type of connection	See selection table
Pull-down resistance	22 kΩ	Ambient temperature: operation	-20 ... +60 °C
Protective circuits	Reverse-polarity protection, U <sub>B</sub> / short-circuit protection (Q)	Ambient temperature: storage	-40 ... +80 °C
Protection Class	2	Weight	See selection table
Power On Delay	≤ 300 ms	Vibration and impact resistance	EN 60947-5-2
Switching output, Q	PNP/NPN		
Output function	N.O./N.C.		
Switching frequency, f (ti/tp 1:1)	See selection table		

<sup>1</sup> Reference material: white, 90 % reflectivity    <sup>2</sup> 10 % ripple, within U<sub>B</sub>    <sup>3</sup> With connected IP 65 plug

Scanning distance	Switching frequency, f (ti/tp 1:1)	Type of connection	Weight	Part number	Article number	No.
1 m	1000 Hz	Plug, M12, 4-pin	210 g	FMS 30-44 UL4-56	530-51591	1
0.5 m	5000 Hz	Plug, M12, 4-pin	210 g	FMS 30-44 UL4-60	530-51592	1
1 m	1000 Hz	Cable, 3 m, 4-wire	320 g	FMS 30-44 U-56	530-51587	2
0.5 m	5000 Hz	Cable, 3 m, 4-wire	310 g	FMS 30-44 U-60	530-51588	2
0.5 m	5000 Hz	Plug, M12, 5-pin	240 g	FMS 30-44 UT-60	530-51596	3
1 m	1000 Hz	Plug, M12, 5-pin	240 g	FMS 30-44 UG-56	530-51590	4
0.5 m	5000 Hz	Plug, M12, 4-pin	240 g	FMS 30-44 UG-60	530-51589	4

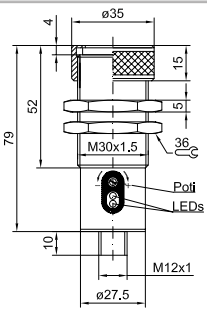
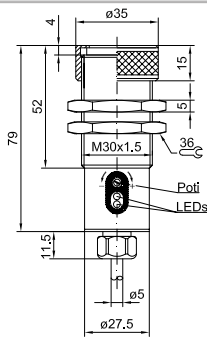
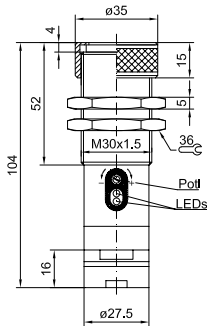
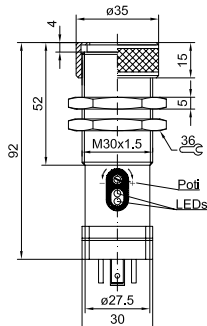
<p>Plug connection, No. 1</p>	<p>Cable connection, No. 2</p>
 <p>153-00005</p>	 <p>153-00004</p>
<p>Plug connection, No. 3</p>	<p>Plug connection. 4</p>
 <p>153-00006</p>	 <p>153-00007</p>

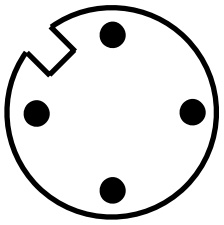
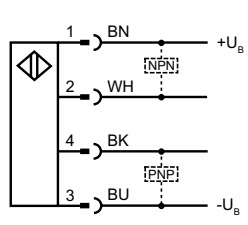
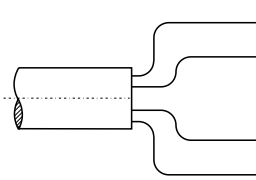
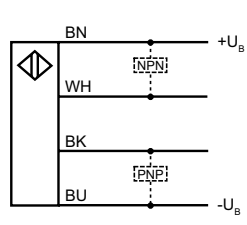
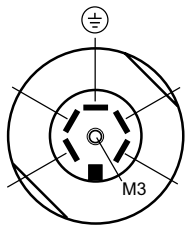
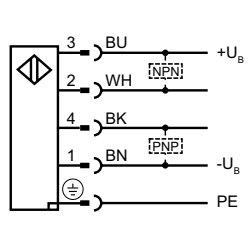
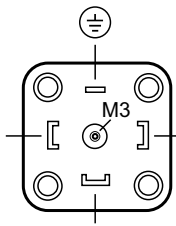
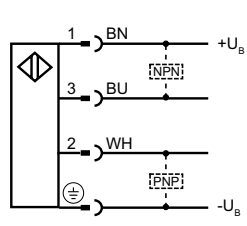
<p>Connection, 4-pin, No. 1</p>	<p>Connection, 4-pin, No. 2</p>
 <p>154-00136</p>  <p>154-00282</p>	 <p>154-00132</p>  <p>154-00282</p>
<p>Connection, 5-pin, No. 3</p>	<p>Connection, 4-pin, No. 4</p>
 <p>154-00145</p>  <p>154-00260</p>	 <p>154-00146</p>  <p>154-00261</p>

N.O./N.C. function

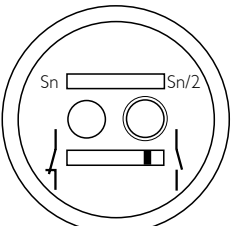
 <p>155-00927</p>	<p>N.O./N.C. function is set via the sliding switch on the front. Switch position "Sn/2" halves scanning distance but permits better resolution.</p>
--	--

# FMS 30-35 U

Photoelectric diffuse sensor for adaptation of fibre-optic cables



## PRODUCT HIGHLIGHTS

- Scanning distance dependant on fibre-optic cable
- Fibre-optic cable adaptable
- Universal PNP/NPN output
- N.O./N.C. selectable
- Contamination indicator / output
- M30 metal threaded sleeve

Optical data		Functions	
Scanning distance	2 m <sup>1</sup>	Indicator LED, green	Operating voltage indicator
Type of light	Infrared, 880 nm	Indicator LED, yellow	Switching output indicator
Distance hysteresis <sup>1</sup>	≤ 10 % of the set scanning distance	Indicator LED, red	Contamination indicator
Aperture angle	< 18 %	Sensitivity adjustment	Via 18-step potentiometer
Electrical data		Mechanical data	
Operating voltage, +U <sub>B</sub>	10 ... 30V DC <sup>2</sup>	Dimensions	See dimensional drawings
No-load current, I <sub>0</sub>	≤ 40 mA	Enclosure rating	IP 65 <sup>3</sup>
Output current, I <sub>e</sub>	≤ 200 mA	Material, housing	Brass, nickel-plated
Pull-up resistance	22 kΩ	Type of connection	See selection table
Pull-down resistance	22 kΩ	Ambient temperature: operation	-20 ... +60 °C
Protective circuits	Reverse-polarity protection, U <sub>B</sub> / short-circuit protection (Q)	Ambient temperature: storage	-40 ... +80 °C
Protection Class	2	Weight (plug device)	215 g
Power On Delay	≤ 300 ms	Weight (cable device)	315 g
Switching output, Q	PNP	Vibration and impact resistance	EN 60947-5-2
Output function	N.O./N.C.		
Switching frequency, f (ti/tp 1:1)	≤ 100 Hz		

<sup>1</sup> Reference material: white, 90 % reflectivity    <sup>2</sup> 10 % ripple, within U<sub>B</sub>    <sup>3</sup> With connected IP 65 plug

Type of connection	Part number	Article number
Cable, 3 m, 4-wire	FMS 30-35 U	544-51323
Plug, M12, 5-pin	FMS 30-35 UL5	544-51324

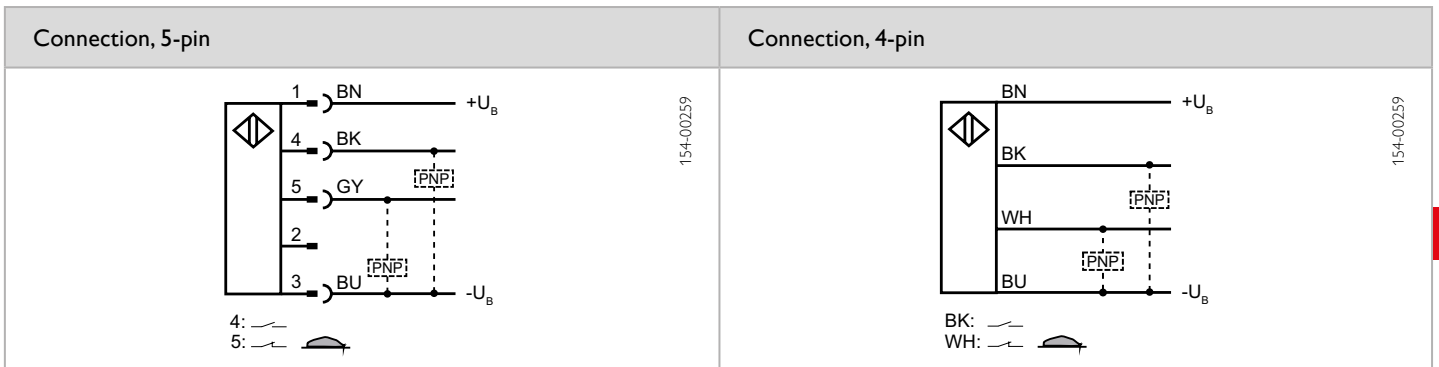
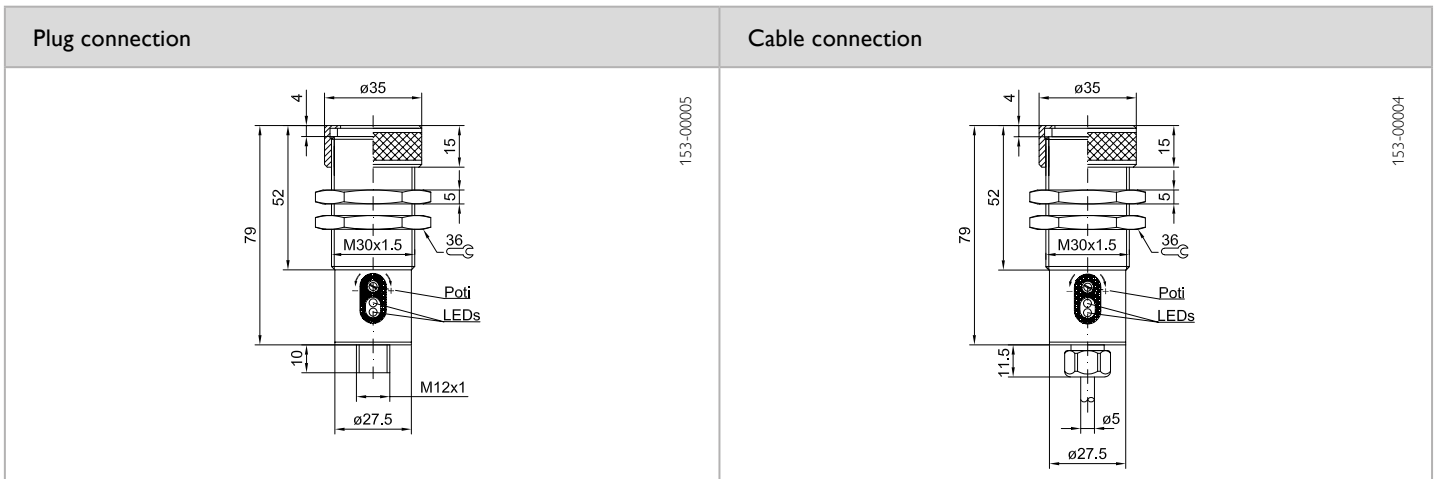

# FMS 30-34 U

Photoelectric diffuse sensor for adaptation of fibre-optic cables



## PRODUCT HIGHLIGHTS

- Our bestseller: ideal for the most diverse applications
- Infrared
- Scanning distance dependant on fibre-optic cable
- Fibre-optic cable adaptable
- N.O./N.C. selectable
- Contamination indicator / output
- M30 metal threaded sleeve

Optical data		Functions	
Scanning distance	1.5 m / 2 m <sup>1</sup>	Indicator LED, green	Operating voltage indicator
Type of light	Infrared, 880 nm / infrared, 950 nm	Indicator LED, yellow	Switching output indicator
Distance hysteresis <sup>1</sup>	< 10 % of the set scanning distance	Indicator LED, red	Contamination indicator
		Sensitivity adjustment	Via 18-step potentiometer
Electrical data		Mechanical data	
Operating voltage, +U <sub>B</sub>	10 ... 30V DC <sup>2</sup>	Dimensions	See dimensional drawings
No-load current, I <sub>0</sub>	≤ 40 mA	Enclosure rating	IP 65 <sup>3</sup>
Output current, I <sub>e</sub>	≤ 200 mA	Material, housing	Brass, nickel-plated
Pull-up resistance	22 kΩ	Type of connection	See selection table
Pull-down resistance	22 kΩ	Ambient temperature: operation	-20 ... +60 °C
Protective circuits	Reverse-polarity protection, U <sub>B</sub> / short-circuit protection (Q)	Ambient temperature: storage	-40 ... +80 °C
Protection Class	2	Weight (plug device)	210 g
Power On Delay	≤ 300 ms	Weight (cable device)	315 g
Switching output, Q	PNP/NPN	Vibration and impact resistance	EN 60947-5-2
Output function	N.O./N.C.		
Switching frequency, f (ti/tp 1:1)	≤ 100 Hz		

<sup>1</sup> Reference material: white, 90 % reflectivity    <sup>2</sup> 10 % ripple, within U<sub>B</sub>    <sup>3</sup>With connected IP 65 plug

Scanning distance	Type of light	Type of connection	Part number	Article number
1.5 m	Infrared, 950 nm	Cable, 3 m, 4-wire	FMS 30-34 U-54	540-51605
2 m	Infrared, 880 nm	Plug, M9x0.5, 4-pin	FMS 30-34 UA4	540-51606

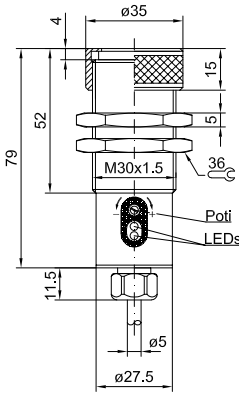
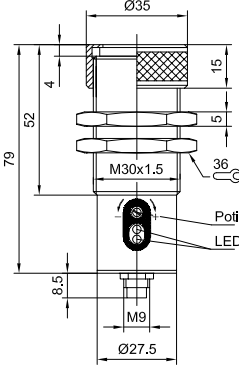
Cable connection	Plug connection: FMS 30-34 UA4
 <p>153-00004</p>	 <p>153-00008</p>

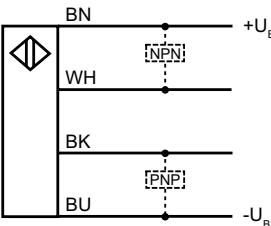
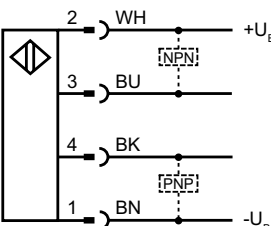
Connection, 4-pin	Connection, 4-pin: FMS 30-34 UA4
 <p>154-00282</p>	 <p>154-00263</p>



# Fibre-optic cables – standard

The right variant for every task

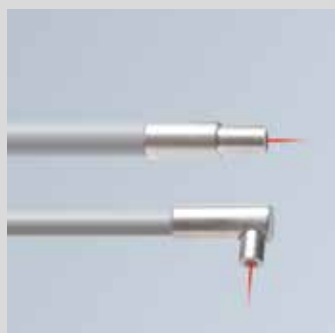

## **Look round the corner**

When space is restricted it can be advantageous to use fibre-optic cables with lateral (straight) light exits – available with differing side lengths, depending on the model.



## **The protective sheath**

Variants with a helical metal sheath (MSC devices) usually meet normal demands. For more difficult operating conditions – for example constant mechanical movements and loads or exposure to water spray, oil, coolants or high temperatures – SensoPart offers fibre-optic cables with silicone sheaths (Si devices).

## TYPICAL SENSOPART FIBRE-OPTIC CABLES

- Long ranges in combination with appropriate photoelectric sensors and diffuse sensors
- Variety of sheath materials, also for harsh operating conditions
- Straight or right-angle light exit for simple installation, even when space is restricted
- Particularly high light output with glass fibres
- High temperature resistance with glass fibres (up to 160°C)
- Coaxial fibres for precise small-part detection
- Flexible plastic fibre-optic cables with very fine mounting heads
- Variety of mounting possibilities (adapters or heads)

Every task is unique and requires an individual sensor solution. Selection of the correct fibre-optic cable is of decisive importance, particularly with difficult and restricted space conditions. We place particular importance on the careful machining of the fibre material, fibre-optic cable ends and sheaths. This special treatment allows long ranges to be achieved, i.e. a sufficiently high light output reaches the target object, is guided back, and reliably evaluated.

Our fibre-optic cables can be adapted to almost every task thanks to the wide range of cables with differing heads and mounting possibilities – from the sheaths, through threaded sleeves or flexible and bendable needle sleeves, to cables that can see around corners.

Special materials, such as PVC, silicone or metal tubes, protect the fibre-optic cables against chemical and mechanical effects and make them temperature-resistant up to 160°C. Whether glass fibres for high light outputs or flexible plastic fibre-optic cables with the smallest of bending angles and very high resistance to vibrations and impacts, our standard fibre-optic cables prove their precision and reliability in everyday harsh industrial use.

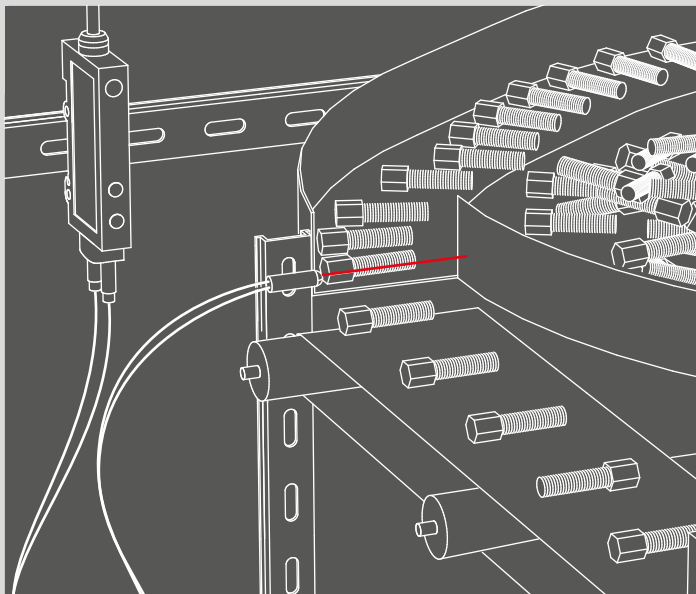

#### Checking the presence of small parts on a vibration conveyor system

An **FL 70 fibre-optic sensor** registers the presence of work-pieces at the end of the feed section.

- Extremely precise switching behaviour
- Simple teach-in with the help of a display
- Very good small-part detection through the use of focused fibre-optic cables
- Broad and individual range of fibre-optic cables for differing tasks
- Flexible arrangement of the fibre-optic cable

# Fibre-optic cables – standard



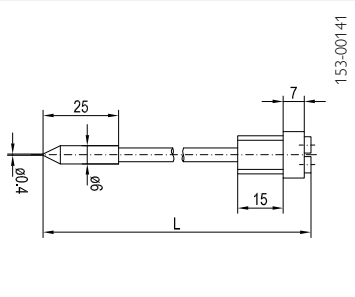

Fibre-optic cable	Diffuse sensor (T) Photoelectric sensor (L)	Typical scanning distance / range	Light exit	Special features	For fibre-optic sensors	
18/30 R. 0,4/xxxx-Si		T	Up to 3 mm	Right-angle	<ul style="list-style-type: none"> <li>Small mounting dimensions</li> <li>Robust design</li> </ul>	FMS 18 / FMS 30
18/30 R. 1/xxxx-Si/MSC/PVC		T	Up to 15 mm	Right-angle	<ul style="list-style-type: none"> <li>Small mounting dimensions</li> <li>Robust design</li> </ul>	FMS 18 / FMS 30
18/30 R. 2/xxxx-Si/MSC/PVC		T	Up to 60 mm	Right-angle	<ul style="list-style-type: none"> <li>Robust design</li> </ul>	FMS 18 / FMS 30
18/30 R. 3/xxxx-Si/MSC/PVC		T	Up to 200 mm	Right-angle	<ul style="list-style-type: none"> <li>Robust design</li> </ul>	FMS 18 / FMS 30
30 R. 4/xxxx-Si/MSC		T	Up to 400 mm	Right-angle	<ul style="list-style-type: none"> <li>Long range</li> <li>Robust design</li> </ul>	FMS 18 / FMS 30
30 R. 12/xxxx-Si/MSC		T	Up to 800 mm	Right-angle	<ul style="list-style-type: none"> <li>Long range</li> <li>Immune to contamination</li> <li>Robust design</li> </ul>	FMS 18 / FMS 30
K1R-101		T	Up to 95 mm	Right-angle	<ul style="list-style-type: none"> <li>Small mounting dimensions</li> <li>Suitable for ancillary lens</li> </ul>	FL 70
K2R-102		T	Up to 295 mm	Right-angle	<ul style="list-style-type: none"> <li>Short fastening sleeve</li> </ul>	FL 70 / FL 20
K2R-6		T	Up to 265 mm	Right-angle	<ul style="list-style-type: none"> <li>Short fastening sleeve</li> </ul>	FL 70 / FL 20
LLK1RM3-PE-1m		T	Up to 55 mm	Right-angle	<ul style="list-style-type: none"> <li>Stainless steel head with low head diameter</li> </ul>	FL 70
LLK2RM6-PE-1m		T	Up to 280 mm	Right-angle	<ul style="list-style-type: none"> <li>Stainless steel head</li> </ul>	FL 70 / FL 20
33R1/xxx-MSC/Si		T	Up to 210 mm	Right-angle	<ul style="list-style-type: none"> <li>Robust design</li> <li>Low damping</li> </ul>	FL 70 / FL 20
K1R-68		T	Up to 200 mm	Right-angle	<ul style="list-style-type: none"> <li>Very small bending radius</li> <li>Suitable for ancillary lens</li> </ul>	FL 70 / FL 20
K1R-35		T	Up to 80 mm	Right-angle	<ul style="list-style-type: none"> <li>Precise switching behaviour on lateral approach</li> <li>Fibre length individually cuttable</li> <li>Suitable for ancillary lens</li> </ul>	FL 70
K2R-25		T	Up to 240 mm	Right-angle	<ul style="list-style-type: none"> <li>Precise switching behaviour on lateral approach</li> <li>Short fastening sleeve</li> </ul>	FL 70 / FL 20
LLK1RKM3-PE-1m		T	Up to 150 mm	Right-angle	<ul style="list-style-type: none"> <li>Precise switching behaviour on lateral approach</li> <li>Suitable for ancillary lens</li> </ul>	FL 70
LLK1RKM3-18-PE-2m		T	Up to 150 mm	Right-angle	<ul style="list-style-type: none"> <li>Precise switching behaviour on lateral approach</li> <li>Short fastening sleeve</li> <li>Suitable for ancillary lens</li> </ul>	FL 70
LLK2RKM6-PE-1m		T	Up to 310 mm	Right-angle	<ul style="list-style-type: none"> <li>Precise switching behaviour on lateral approach</li> </ul>	FL 70 / FL 20
18/30 RZ 1/xxxx-Si/MSC		T	Up to 15 mm	Straight	<ul style="list-style-type: none"> <li>For restricted spaces</li> <li>Robust design</li> <li>Low damping</li> </ul>	FMS 18 / FMS 30
18/30 RZ 2/xxxx-Si/MSC/PVC		T	Up to 60 mm	Straight	<ul style="list-style-type: none"> <li>For restricted spaces</li> <li>Robust design</li> <li>Low damping</li> </ul>	FMS 18 / FMS 30
18/30 RZ 3/xxxx-Si/MSC/PVC		T	Up to 200 mm	Straight	<ul style="list-style-type: none"> <li>For restricted spaces</li> <li>Robust design</li> <li>Low damping</li> </ul>	FMS 18 / FMS 30
30 RZ 4/xxxx-Si/MSC		T	Up to 400 mm	Straight	<ul style="list-style-type: none"> <li>For restricted spaces</li> <li>Long range</li> <li>Robust design</li> </ul>	FMS 18 / FMS 30
30 RZ 12/xxxx-Si/MSC		T	Up to 800 mm	Straight	<ul style="list-style-type: none"> <li>For restricted spaces</li> <li>Long range</li> <li>Robust design</li> <li>Immune to contamination</li> </ul>	FMS 18 / FMS 30
33 RZ 1/xxx-MSC		T	Up to 210 mm	Straight	<ul style="list-style-type: none"> <li>For restricted spaces</li> <li>Robust design</li> <li>Low damping</li> </ul>	FL 70 / FL 20
LLK2RZ (L5=10)		T	Up to 200 mm	Straight	<ul style="list-style-type: none"> <li>For restricted spaces</li> <li>Precise switching behaviour on lateral approach</li> </ul>	FL 70 / FL 20
K1RZ-31		T	Up to 30 mm	Straight	<ul style="list-style-type: none"> <li>For restricted spaces</li> <li>Very fine stainless steel tip</li> </ul>	FL 70

Fibre-optic cable		Diffuse sensor (T) Photoelectric sensor (L)	Typical scanning distance / range	Light exit	Special features	For fibre-optic sensors
18/30 L 0,4/xxxx-Si		L	Up to 20 mm	Right-angle	<ul style="list-style-type: none"> <li>Small mounting dimensions</li> <li>Robust design</li> </ul>	FMS 18 / FMS 30
18/30 L 1/xxxx-Si/MSC/PVC		L	Up to 100 mm	Right-angle	<ul style="list-style-type: none"> <li>Small mounting dimensions</li> <li>Robust design</li> </ul>	FMS 18 / FMS 30
18/30 L 2/xxxx-Si/MSC/PVC		L	Up to 400 mm	Right-angle	<ul style="list-style-type: none"> <li>Robust design</li> </ul>	FMS 18 / FMS 30
18/30 L 3/xxxx-Si/MSC/PVC		L	Up to 1000 mm	Right-angle	<ul style="list-style-type: none"> <li>Long range</li> <li>Robust design</li> </ul>	FMS 18 / FMS 30
30 L 4/xxxx-Si/MSC		L	Up to 3000 mm	Right-angle	<ul style="list-style-type: none"> <li>Long range</li> <li>Robust design</li> </ul>	FMS 18 / FMS 30
30 L 12/xxxx-Si/MSC		L	Up to 4800 mm	Right-angle	<ul style="list-style-type: none"> <li>Long range</li> <li>Robust design</li> <li>Immune to contamination</li> </ul>	FMS 18 / FMS 30
K2L-201		L	Up to 200 mm	Right-angle	<ul style="list-style-type: none"> <li>Small mounting dimensions</li> <li>Suitable for ancillary lens</li> </ul>	FL 70 / FL 20
K2L-202		L	Up to 800 mm	Right-angle	<ul style="list-style-type: none"> <li>Short fastening sleeve</li> <li>Suitable for ancillary lens</li> </ul>	FL 70 / FL 20
K2L-7		L	Up to 810 mm	Right-angle	<ul style="list-style-type: none"> <li>Small mounting dimensions</li> <li>Suitable for ancillary lens</li> </ul>	FL 70 / FL 20
K2L-77		L	Up to 550 mm	Right-angle	<ul style="list-style-type: none"> <li>Oil-resistant</li> <li>Expanded temperature range</li> <li>Suitable for ancillary lens</li> </ul>	FL 70 / FL 20
LLK2LM3-PE-1m		L	Up to 240 mm	Right-angle	<ul style="list-style-type: none"> <li>Stainless steel head</li> <li>Suitable for ancillary lens</li> <li>Small mounting dimensions</li> </ul>	FL 70 / FL 20
LLK2LM4-PE-1m		L	Up to 780 mm	Right-angle	<ul style="list-style-type: none"> <li>Stainless steel head</li> <li>Suitable for ancillary lens</li> </ul>	FL 70 / FL 20
K1L-78		L	Up to 405 mm	Right-angle	<ul style="list-style-type: none"> <li>Very small bending radius</li> <li>Small mounting dimensions</li> <li>Suitable for ancillary lens</li> </ul>	FL 70 / FL 20
33L1/500-MSC		L	Up to 550 mm	Right-angle	<ul style="list-style-type: none"> <li>Robust design</li> <li>Low damping</li> <li>Suitable for ancillary lens</li> </ul>	FL 70 / FL 20
18/30 LZ 1/xxxx-Si/MSC		L	Up to 100 mm	Straight	<ul style="list-style-type: none"> <li>For restricted spaces</li> <li>Robust design</li> <li>Low damping</li> </ul>	FMS 18 / FMS 30
18/30 LZ 2/xxxx-Si/MSC/PVC		L	Up to 400 mm	Straight	<ul style="list-style-type: none"> <li>For restricted spaces</li> <li>Robust design</li> <li>Various sheaths</li> <li>Low damping</li> </ul>	FMS 18 / FMS 30
18/30 LZ 3/xxxx-Si/MSC/PVC		L	Up to 1000 mm	Straight	<ul style="list-style-type: none"> <li>For restricted spaces</li> <li>Robust design</li> <li>Low damping</li> <li>Expanded range</li> </ul>	FMS 18 / FMS 30
30 LZ 4/xxxx-Si/MSC		L	Up to 3000 mm	Straight	<ul style="list-style-type: none"> <li>For restricted spaces</li> <li>Robust design</li> <li>Low damping</li> <li>Long range</li> </ul>	FMS 18 / FMS 30
30 LZ 12/xxxx-Si/MSC		L	Up to 4800 mm	Straight	<ul style="list-style-type: none"> <li>For restricted spaces</li> <li>Robust design</li> <li>Low damping</li> <li>Long range</li> <li>Immune to contamination</li> </ul>	FMS 18 / FMS 30
33 LZ 1/xxx-Si/MSC		L	Up to 550 mm	Straight	<ul style="list-style-type: none"> <li>For restricted spaces</li> <li>Robust design</li> <li>Low damping</li> </ul>	FL 70 / FL 20
LLK2LZ		L	Up to 600 mm	Straight	<ul style="list-style-type: none"> <li>For restricted spaces</li> <li>Precise switching behaviour on lateral approach</li> <li>Fibre length individually cuttable</li> </ul>	FL 70 / FL 20
K2L-34		L	Up to 150 mm	Straight	<ul style="list-style-type: none"> <li>For restricted spaces</li> <li>Very fine tip</li> </ul>	FL 70 / FL 20

# Fibre-optic cables – standard

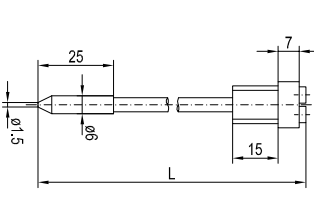

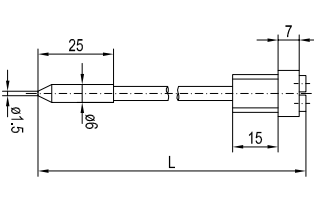

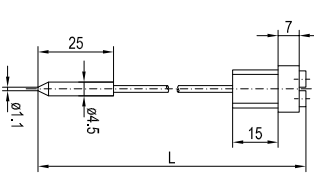
18/30 R 0,4/...-Si fibre-optic cable					Highlights				
					<ul style="list-style-type: none"> <li>• Photoelectric diffuse sensor</li> <li>• Silicone sheath</li> <li>• Small right-angle light exit</li> <li>• Robust design</li> <li>• -20 ... 160 °C</li> <li>• Fixing via mounting block MB 6 (Article number 903-05139)</li> <li>• For FMS devices</li> </ul>				
Fibre arrangement Light exit	FMS 18 typ. scanning distance/range (mm)	FMS 30 typ. scanning distance/range (mm)	Core fibre Ø (mm) material	Sheath material	Ambient temperature (rigid installation)	Bending radius (mm)	Cable length (m)	Collar bushing Ø (mm)	LS (mm)
Right-angle	1	3	1 x 0,4 Glass	Silicone (Si)	-20 ... 160 °C	15	See Selection Table	6	–

Length (m)	Part number	Article number
0.25	18/30 R 0,4/250-Si	979-50551
0.5	18/30 R 0,4/500-Si	979-50552
1	18/30 R 0,4/1000-Si	979-50544
2	18/30 R 0,4/2000-Si	979-50553



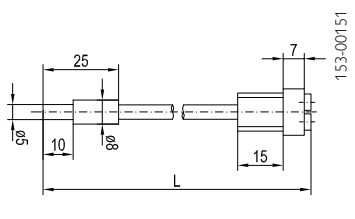

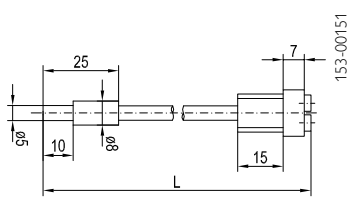
18/30 R 1/...-Si fibre-optic cable		Highlights								
		<ul style="list-style-type: none"> <li>• Photoelectric diffuse sensor</li> <li>• Silicone, metal or PVC sheath</li> <li>• Small right-angle light exit</li> <li>• Robust design</li> <li>• -20 ... +80°C / +160 °C</li> <li>• Fixing via mounting block MB 6 (MSC/Si) (Article number 903-05139)</li> <li>• Fixing via mounting block MB 4.5 (PVC) (Article number 903-50314)</li> <li>• For FMS devices</li> </ul>								
18/30 R 1/...-MSC fibre-optic cable										
										
18/30 R 1/...-PVC fibre-optic cable										
										
Fibre arrangement	FMS 18 typ. scanning distance/range (mm)	FMS 30 typ. scanning distance/range (mm)	Core fibre Ø (mm) material	Sheath material	Ambient temperature (rigid installation)	Bending radius (mm)	Cable length (m)	Collar bushing Ø (mm)	LS (mm)	
Right-angle	5	15	1 x 0.8 (Si/MSC) 1 x 1.0 (PVC) Glass	See Selection Table	-20 ... +160 °C (Si/MSC) -20 ... +80 °C (PVC)	15 = (Si/MSC) 10 = (PVC)	See Selection Table	6 = (Si/MSC) 4.5 = (PVC)	-	

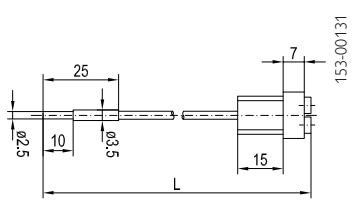
Length (m)	Sheath material	Part number	Article number
0.25	Silicone (Si)	18/30 R 1/250-Si	979-08081
0.5	Silicone (Si)	18/30 R 1/500-Si	979-08082
0.75	Silicone (Si)	18/30 R 1/750-Si	979-08407
1	Silicone (Si)	18/30 R 1/1000-Si	979-08083
1.5	Silicone (Si)	18/30 R 1/1500-Si	979-08408
2	Silicone (Si)	18/30 R 1/2000-Si	979-08084
0.25	Brass, chrome-plated (MSC)	18/30 R 1/250-MSC	979-08057
0.5	Brass, chrome-plated (MSC)	18/30 R 1/500-MSC	979-08058
0.75	Brass, chrome-plated (MSC)	18/30 R 1/750-MSC	979-08387
1	Brass, chrome-plated (MSC)	18/30 R 1/1000-MSC	979-08059
1.5	Brass, chrome-plated (MSC)	18/30 R 1/1500-MSC	979-08388
2	Brass, chrome-plated (MSC)	18/30 R 1/2000-MSC	979-08060
0.25	PVC	18/30 R 1/250 PVC	979-08044
0.5	PVC	18/30 R 1/500 PVC	979-08045
0.75	PVC	18/30 R 1/750-PVC	979-08381
1	PVC	18/30 R 1/1000 PVC	979-08046
1.5	PVC	18/30 R 1/1500 PVC	979-08382
2	PVC	18/30 R 1/2000 PVC	979-08047

# Fibre-optic cables – standard

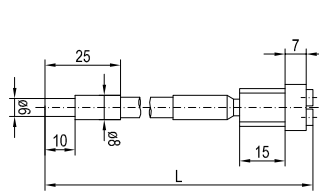
18/30 R 2/...-Si fibre-optic cable					Highlights				
					<ul style="list-style-type: none"> <li>• Photoelectric diffuse sensor</li> <li>• Silicone, metal or PVC sheath</li> <li>• Right-angle light exit</li> <li>• Robust design</li> <li>• -20 ... +80 °C / +160 °C</li> <li>• Fixing via mounting block MB 8 (MSC/Si) (Article number 903-05141)</li> <li>• Fixing via mounting block MB 3.5 (PVC) (Article number 903-50313)</li> <li>• For FMS devices</li> </ul>				
18/30 R 2/...-MSC fibre-optic cable									
									
18/30 R 2/...-PVC fibre-optic cable									
									
Fibre arrangement	FMS 18 typ. scanning distance/range (mm)	FMS 30 typ. scanning distance/range (mm)	Core fibre Ø (mm) material	Sheath material	Ambient temperature (rigid installation)	Bending radius (mm)	Cable length (m)	Collar bushing Ø (mm)	LS (mm)
Right-angle	50	60	1 x 1.6 (Si/MSC) 1 x 1.5 (PVC) Glass	See Selection Table	-20 ... +160 °C (Si/MSC) -20 ... +80 °C (PVC)	20 = (Si/MSC) 15 = (PVC)	See Selection Table	8 = (Si/MSC) 3.5 = (PVC)	-

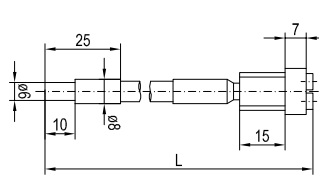

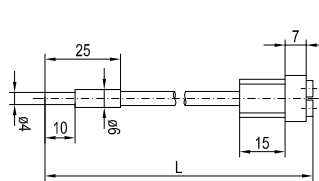
Length (m)	Sheath material	Part number	Article number
0.25	Silicone (Si)	18/30 R 2/250-Si	979-08089
0.5	Silicone (Si)	18/30 R 2/500-Si	979-08090
0.75	Silicone (Si)	18/30 R 2/750-Si	979-08411
1	Silicone (Si)	18/30 R 2/1000-Si	979-08091
1.5	Silicone (Si)	18/30 R 2/1500-Si	979-08412
2	Silicone (Si)	18/30 R 2/2000-Si	979-08092
0.25	Brass, chrome-plated (MSC)	18/30 R 2/250-MSC	979-08061
0.5	Brass, chrome-plated (MSC)	18/30 R 2/500-MSC	979-08062
0.75	Brass, chrome-plated (MSC)	18/30 R 2/750-MSC	979-08389
1	Brass, chrome-plated (MSC)	18/30 R 2/1000-MSC	979-08063
1.5	Brass, chrome-plated (MSC)	18/30 R 2/1500-MSC	979-08390
2	Brass, chrome-plated (MSC)	18/30 R 2/2000-MSC	979-08064
0.25	PVC	18/30 R 2/250 PVC	979-08048
0.5	PVC	18/30 R 2/500 PVC	979-08049
0.75	PVC	18/30 R 2/750 PVC	979-08383
1	PVC	18/30 R 2/1000 PVC	979-08050
1.5	PVC	18/30 R 2/1500 PVC	979-08384
2	PVC	18/30 R 2/2000 PVC	979-08051

18/30 R 3/...-Si fibre-optic cable		Highlights								
		<ul style="list-style-type: none"> <li>• Photoelectric diffuse sensor</li> <li>• Silicone, metal or PVC sheath</li> <li>• Right-angle light exit</li> <li>• Robust design</li> <li>• -20 ... +80 °C / +160 °C</li> <li>• Fixing via mounting block MB 8 (MSC/Si) (Article number 903-05141)</li> <li>• Fixing via mounting block MB 6 (PVC) (Article number 903-05139)</li> <li>• For FMS devices</li> </ul>								
18/30 R 3/...-MSC fibre-optic cable										
										
18/30 R 3/...-PVC fibre-optic cable		<ul style="list-style-type: none"> <li>• Photoelectric diffuse sensor</li> <li>• Silicone, metal or PVC sheath</li> <li>• Right-angle light exit</li> <li>• Robust design</li> <li>• -20 ... +80 °C / +160 °C</li> <li>• Fixing via mounting block MB 8 (MSC/Si) (Article number 903-05141)</li> <li>• Fixing via mounting block MB 6 (PVC) (Article number 903-05139)</li> <li>• For FMS devices</li> </ul>								
										
Fibre arrangement	FMS 18 typ. scanning distance/range (mm)	FMS 30 typ. scanning distance/range (mm)	Core fibre Ø (mm) material	Sheath material	Ambient temperature (rigid installation)	Bending radius (mm)	Cable length (m)	Collar bushing Ø (mm)	LS (mm)	
Right-angle	160	200	2 x 2.0 (Si/MSC) 1 x 2.8 (PVC) Glass	See Selection Table	-20 ... +160 °C (Si/MSC) -20 ... +80 °C (PVC)	25 = (Si/MSC) 30 = (PVC)	See Selection Table	8 = (Si/MSC) 6 = (PVC)	-	

Length (m)	Sheath material	Part number	Article number
0.25	Silicone (Si)	18/30 R 3/250-Si	979-08093
0.5	Silicone (Si)	18/30 R 3/500-Si	979-08094
0.75	Silicone (Si)	18/30 R 3/750-Si	979-08413
1	Silicone (Si)	18/30 R 3/1000-Si	979-08095
1.5	Silicone (Si)	18/30 R 3/1500-Si	979-08414
2	Silicone (Si)	18/30 R 3/2000-Si	979-08096
0.25	Brass, chrome-plated (MSC)	18/30 R 3/250-MSC	979-08065
0.5	Brass, chrome-plated (MSC)	18/30 R 3/500-MSC	979-08066
0.75	Brass, chrome-plated (MSC)	18/30 R 3/750-MSC	979-08391
1	Brass, chrome-plated (MSC)	18/30 R 3/1000-MSC	979-08067
1.5	Brass, chrome-plated (MSC)	18/30 R 3/1500-MSC	979-08392
2	Brass, chrome-plated (MSC)	18/30 R 3/2000-MSC	979-08068
0.25	PVC	18/30 R 3/250 PVC	979-08052
0.5	PVC	18/30 R 3/500 PVC	979-08053
0.75	PVC	18/30 R 3/750 PVC	979-08385
1	PVC	18/30 R 3/1000 PVC	979-08054
1.5	PVC	18/30 R 3/1500 PVC	979-08386
2	PVC	18/30 R 3/2000 PVC	979-08055

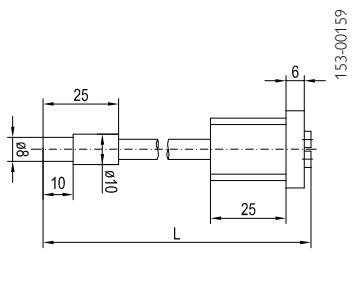

# Fibre-optic cables – standard

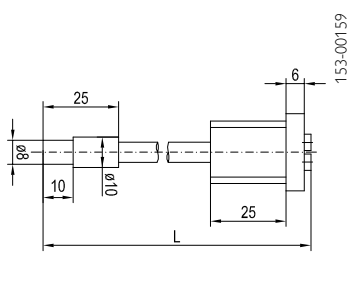
30 R 4/...-Si fibre-optic cable					Highlights				
					<ul style="list-style-type: none"> <li>• Photoelectric diffuse sensor</li> <li>• Silicone, metal or PVC sheath</li> <li>• Right-angle light exit</li> <li>• Long scanning distance/range</li> <li>• Robust design</li> <li>• -20 ... +160 °C</li> <li>• Fixing via mounting block MB 10 (Article number 903-05142)</li> <li>• For FMS devices</li> </ul>				
30 R 4/...-MSC fibre-optic cable									
									
Fibre arrangement	FMS 18 typ. scanning distance/range (mm)	FMS 30 typ. scanning distance/range (mm)	Core fibre Ø (mm) material	Sheath material	Ambient temperature (rigid installation)	Bending radius (mm)	Cable length (m)	Collar bushing Ø (mm)	LS (mm)
Right-angle	–	400	2 x 2.3 Glass	See Selection Table	-20 ... +160 °C	25	See Selection Table	10	–

Length (m)	Sheath material	Part number	Article number
0.25	Silicone (Si)	30 R 4/250-Si	979-06924
0.5	Silicone (Si)	30 R 4/500-Si	979-06925
0.75	Silicone (Si)	30 R 4/750-Si	979-08415
1	Silicone (Si)	30 R 4/1000-Si	979-06926
1.5	Silicone (Si)	30 R 4/1500-Si	979-08416
2	Silicone (Si)	30 R 4/2000-Si	979-06927
0.25	Brass. chrome-plated (MSC)	30 R 4/250-MSC	979-06654
0.5	Brass. chrome-plated (MSC)	30 R 4/500-MSC	979-06655
0.75	Brass. chrome-plated (MSC)	30 R 4/750-MSC	979-08393
1	Brass. chrome-plated (MSC)	30 R 4/1000-MSC	979-06656
1.5	Brass. chrome-plated (MSC)	30 R 4/1500-MSC	979-08394
2	Brass. chrome-plated (MSC)	30 R 4/2000-MSC	979-06657

30 R 12/...-Si fibre-optic cable				Highlights						
				<ul style="list-style-type: none"> <li>• Photoelectric diffuse sensor</li> <li>• Silicone, metal or PVC sheath</li> <li>• Right-angle light exit</li> <li>• Extremely insensitive to contamination</li> <li>• Long scanning distance/range</li> <li>• Robust design</li> <li>• -20 ... +160 °C</li> <li>• Fixing via mounting block MB 10 (Article number 903-05142)</li> <li>• For FMS devices</li> </ul>						
30 R 12/...-MSC fibre-optic cable										
Fibre arrangement	FMS 18 typ. scanning distance/range (mm)	FMS 30 typ. scanning distance/range (mm)	Core fibre Ø (mm) material	Sheath material	Ambient temperature (rigid installation)	Bending radius (mm)	Cable length (m)	Collar bushing Ø (mm)	LS (mm)	
Right-angle	–	800	2 x 3.5 Glass	See Selection Table	-20 ... +160 °C	45	See Selection Table	12	–	

Length (m)	Sheath material	Part number	Article number
0.25	Silicone (Si)	30 R 12/250-Si	979-06940
0.5	Silicone (Si)	30 R 12/500-Si	979-06941
0.75	Silicone (Si)	30 R 12/750-Si	979-08417
1	Silicone (Si)	30 R 12/1000-Si	979-06942
1.5	Silicone (Si)	30 R 12/1500-Si	979-08418
2	Silicone (Si)	30 R 12/2000-Si	979-06943
0.25	Stainless steel (V2A chrome plated)	30 R 12/250-MSC	979-06646
0.5	Stainless steel (V2A chrome plated)	30 R 12/500-MSC	979-06647
0.75	Stainless steel (V2A chrome plated)	30 R 12/750-MSC	979-08395
1	Stainless steel (V2A chrome plated)	30 R 12/1000-MSC	979-06648
1.5	Stainless steel (V2A chrome plated)	30 R 12/1500-MSC	979-08396
2	Stainless steel (V2A chrome plated)	30 R 12/2000-MSC	979-06643

# Fibre-optic cables – standard

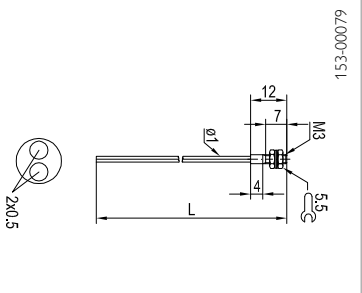
K1R-101 fibre-optic cable					Highlights						
					<ul style="list-style-type: none"> <li>• Photoelectric diffuse sensor</li> <li>• Small installation dimensions</li> <li>• Fibre length individually cuttable</li> <li>• For FL 70 devices</li> </ul>						
Design	FL 70	Fibre	Suitable	Core fibre	Sheath	Ambient	Fibre	Cable	Collar	LS	
Light exit	typ. scanning distance (mm) Standard / Fine / High	arrangement	for ancillary lens	Ø (mm) (T = Transmitter; R = Receiver) Material	material	temperature (rigid installation)	bending radius (mm)	length	bushing	(mm)	
Mono/ right-angle	60 / 25 / 95	See drawing	LVL6-M3	2 x 0.5 (T/R) PMMA	Polyethylene (PE)	-40 ... +70 °C	25	2 m Cuttable	M3 Stainless steel	–	

Part number	Article number
K1R-101	720-50766

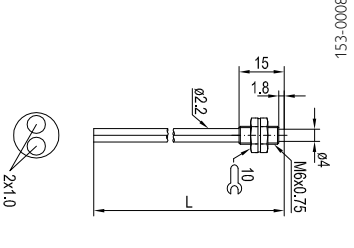
K2R-102 fibre-optic cable					Highlights						
					<ul style="list-style-type: none"> <li>• Photoelectric diffuse sensor</li> <li>• Short mounting sleeve</li> <li>• Fibre length individually cuttable</li> <li>• For FL 70/FL 20 devices</li> </ul>						
Design	FL 70	FL 20	Fibre	Suitable	Core fibre	Sheath	Ambient	Fibre	Cable	Collar	LS
Light exit	typ. scanning distance (mm) Standard / Fine / High	typ. scanning distance (mm) Default setting	arrangement	for ancillary lens	Ø (mm) (T = Transmitter; R = Receiver) Material	material	temperature (rigid installation)	bending radius (mm)	length	bushing	(mm)
Mono/ right-angle	150 / 85 / 295	80	See drawing	–	2 x 1.0 (T/R) PMMA	Polyethylene (PE)	-40 ... +70 °C	25	2 m Cuttable	M6x0.75 Stainless steel	–

Part number	Article number
K2R-102	720-50767

K2R-6 fibre-optic cable						Highlights					
						<ul style="list-style-type: none"> <li>• Photoelectric diffuse sensor</li> <li>• Fibre length individually cuttable</li> <li>• For FL 70/FL 20 devices</li> </ul>					
Design	FL 70 typ. scanning distance (mm) Standard / Fine / High	FL 20 typ. scanning distance (mm) Default setting	Fibre arrange- ment	Suitable for ancillary lens	Core fibre Ø (mm) (T = Transmitter; R = Receiver) Material	Sheath material	Ambient temperature (rigid installation)	Fibre bending radius (mm)	Cable length	Collar bushing	LS (mm)
Mono/ right-angle	100 / 55 / 265	50	See drawing	–	2 x 1.0 (T/R) PMMA	Polyethylene (PE)	-40 ... +70 °C	25	2 m Cuttable	M6x0.75 Stainless steel	–

Part number	Article number
K2R-6	841-21000

# Fibre-optic cables – standard

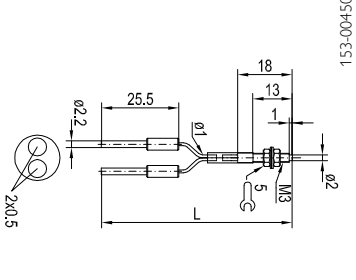
LLK1RM3-PE-1m fibre-optic cable					Highlights						
					<ul style="list-style-type: none"> <li>• Photoelectric diffuse sensor</li> <li>• Very small head diameter</li> <li>• Stainless steel head</li> <li>• Fibre length individually cuttable</li> <li>• For FL 70 devices</li> </ul>						
Design Light exit	FL 70 typ. scanning distance (mm) Standard / Fine / High	Fibre arrangement	Suitable for ancillary lens	Core fibre Ø (mm) (T = Transmitter; R = Receiver) Material	Sheath material	Ambient temperature (rigid installation)	Fibre bending radius (mm)	Cable length	Collar bushing	LS (mm)	
Mono/ right-angle	50 / 20 / 55	See drawing	LVL6-M3	2 x 0.5 (T/R) PMMA	Polyethylene (PE)	-40 ... +60 °C	15	1 m Cuttable	M3 Stainless steel	–	

Part number	Article number
LLK1RM3-PE-1m	750-21000

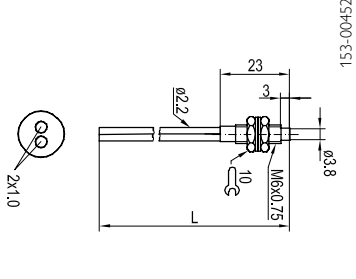
LLK2RM6-PE-1m fibre-optic cable					Highlights						
					<ul style="list-style-type: none"> <li>• Photoelectric diffuse sensor</li> <li>• Robust design</li> <li>• Stainless steel head</li> <li>• Fibre length individually cuttable</li> <li>• For FL 70/FL 20 devices</li> </ul>						
Design Light exit	FL 70 typ. scanning distance (mm) Standard / Fine / High	FL 20 typ. scanning distance (mm) Default setting	Fibre arrangement	Suitable for ancillary lens	Core fibre Ø (mm) (T = Transmitter; R = Receiver) Material	Sheath material	Ambient temperature (rigid installation)	Fibre bending radius (mm)	Cable length	Collar bushing	LS (mm)
Mono/ right-angle	150 / 90 / 280	80	See drawing	–	2 x 1.0 (T/R) PMMA	Polyethylene (PE)	-40 ... +60 °C	25	1 m Cuttable	M6x0.75 Stainless steel	–

Part number	Article number
LLK2RM6-PE-1m	750-21001

33 R 1/...-Si fibre-optic cable						Highlights					
						<ul style="list-style-type: none"> <li>• Photoelectric diffuse sensor</li> <li>• Silicone or metal sheath</li> <li>• Robust design</li> <li>• -20 ... +160 °C</li> <li>• Low damping</li> <li>• For FL 70/FL 20 devices</li> </ul>					
33 R 1/...-MSC fibre-optic cable											
Design Light exit	FL 70 typ. scanning distance (mm) Standard / Fine / High	FL 20 typ. scanning distance (mm) Default setting	Fibre arrangement	Suitable for ancillary lens	Core fibre Ø (mm) (T = Transmitter; R = Receiver) Material	Sheath material	Ambient temperature (rigid installation)	Fibre bending radius (mm)	Cable length	Collar bushing	LS (mm)
Right-angle	100 / 55 / 210	50	See drawing	–	1 x 1.0 (T/R) Glass	See Selection Table	-20 ... +160 °C	15	See Selection Table	M6x0,75 Brass, nickel-plated	–

Length (m)	Sheath material	Part number	Article number
0.5	Silicone (Si)	33 R 1/500-Si	979-51445
0.5	Brass, chrome-plated (MSC)	33 R 1/500 MSC	979-51443
1	Brass, chrome-plated (MSC)	33 R 1/1000 MSC	979-51448
1.5	Brass, chrome-plated (MSC)	33 R 1/1500 MSC	979-51444
2	Brass, chrome-plated (MSC)	33 R 1/2000 MSC	979-51456

# Fibre-optic cables – standard

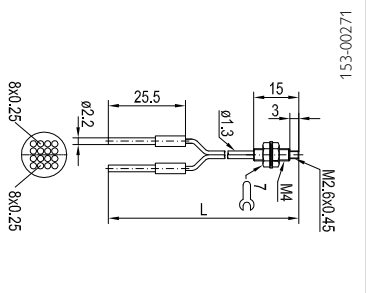
K1R-68 fibre-optic cable				Highlights								
				<ul style="list-style-type: none"> <li>• Photoelectric diffuse sensor</li> <li>• Very small bending radius</li> <li>• Head with mounting thread for attachments</li> <li>• Fibre length individually cutable</li> <li>• For FL 70/FL 20 devices</li> </ul>								
Design	Light exit	FL 70 typ. scanning distance (mm) Standard / Fine / High	FL 20 typ. scanning distance (mm) Default setting	Fibre arrangement	Suitable for ancillary lens	Core fibre Ø (mm) (T = Transmitter; R = Receiver) Material	Sheath material	Ambient temperature (rigid installation)	Fibre bending radius (mm)	Cable length	Collar bushing	LS (mm)
Right-angle		100 / 40 / 200	50	See drawing	LVL6-M4	8 x 0.25 (T) 8 x 0.25 (R) PMMA	Polyethylene (PE)	-40 ... +70 °C	3	2 m Cutable	M4 Brass, nickel-plated	–

Part number	Article number
K1R-68	951-50001

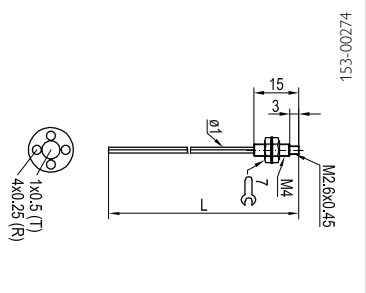
K1R-35 fibre-optic cable				Highlights							
				<ul style="list-style-type: none"> <li>• Photoelectric diffuse sensor</li> <li>• Precise switching behaviour on lateral approach</li> <li>• Head with mounting thread for attachments</li> <li>• Fibre length individually cutable</li> <li>• For FL 70 devices</li> </ul>							
Design	Light exit	FL 70 typ. scanning distance (mm) Standard / Fine / High	Fibre arrangement	Suitable for ancillary lens	Core fibre Ø (mm) (T = Transmitter; R = Receiver) Material	Sheath material	Ambient temperature (rigid installation)	Fibre bending radius (mm)	Cable length	Collar bushing	LS (mm)
Coaxial		50 / 20 / 80	See drawing	LVL6-M4	4 x 0.25 (R) 1 x 0.5 (T) PMMA	Polyethylene (PE)	-40 ... +70 °C	15	2 m Cutable	M4 Brass, nickel-plated	–

Part number	Article number
K1R-35	841-21005

K2R-25 fibre-optic cable						Highlights					
						<ul style="list-style-type: none"> <li>• Photoelectric diffuse sensor</li> <li>• Precise switching behaviour on lateral approach</li> <li>• Short mounting sleeve</li> <li>• Fibre length individually cuttable</li> <li>• For FL 70/FL 20 devices</li> </ul>					
Design Light exit	FL 70 typ. scanning distance (mm) Standard / Fine / High	FL 20 typ. scanning distance (mm) Default setting	Fibre arrangement	Suitable for ancillary lens	Core fibre Ø (mm) (T = Transmitter; R = Receiver) Material	Sheath material	Ambient temperature (rigid installation)	Fibre bending radius (mm)	Cable length	Collar bushing	LS (mm)
Coaxial	130 / 60 / 240	70	See drawing	–	16 x 0.25 (R) 1 x 1.0 (T) PMMA	Polyethylene (PE)	-40 ... +70 °C	25	2 m Cuttable	M6x0.75 Brass, nickel-plated	–

Part number	Article number
K2R-25	841-21004

LLK1RKM3 PE-1m fibre-optic cable						Highlights					
						<ul style="list-style-type: none"> <li>• Photoelectric diffuse sensor</li> <li>• Precise switching behaviour on lateral approach</li> <li>• Very small head diameter</li> <li>• Stainless steel head</li> <li>• Fibre length individually cuttable</li> <li>• For FL 70 devices</li> </ul>					
Design Light exit	FL 70 typ. scanning distance (mm) Standard / Fine / High	Fibre arrangement	Suitable for ancillary lens	Core fibre Ø (mm) (T = Transmitter; R = Receiver) Material	Sheath material	Ambient temperature (rigid installation)	Fibre bending radius (mm)	Cable length	Collar bushing	LS (mm)	
Coaxial	70 / 35 / 150	See drawing	LVLf6-M3	9 x 0.25 (R) 1 x 0.5 (T) PMMA	Polyethylene (PE)	-40 ... +60 °C	15	1 m Cuttable	M3 Stainless steel	–	

Part number	Article number
LLK1RKM3 PE-1m	750-21002







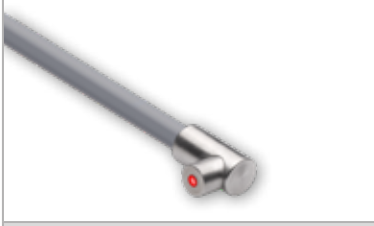
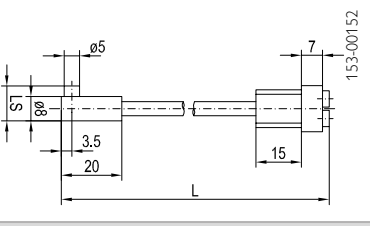

18/30 RZ 1/...-Si fibre-optic cable					Highlights				
					<ul style="list-style-type: none"> <li>• Photoelectric diffuse sensor</li> <li>• Silicone or metal sheath</li> <li>• Straight light exit</li> <li>• Robust design</li> <li>• -20 ... +160 °C</li> <li>• Fixing via mounting block MB 6 (Article number 903-05139)</li> <li>• For FMS devices</li> </ul>				
18/30 RZ 1/...-MSC fibre-optic cable									
Fibre arrangement Light exit	FMS 18 typ. scanning distance/range (mm)	FMS 30 typ. scanning distance/range (mm)	Core fibre Ø (mm) material	Sheath material	Ambient temperature (rigid installation)	Bending radius (mm)	Cable length (m)	Collar bushing Ø (mm)	LS (mm)
Straight	5	15	1 x 1.0 Glass	See Selection Table	-20 ... +160 °C	15	See Selection Table	6	See Selection Table

LS (mm)	Length (m)	Sheath material	Part number	Article number
10	0.25	Silicone (Si)	18/30 RZ 1/250-Si	979-06146
14	0.25	Silicone (Si)	18/30 RZ 1/250-Si	979-06147
10	0.5	Silicone (Si)	18/30 RZ 1/500-Si	979-06152
14	0.5	Silicone (Si)	18/30 RZ 1/500-Si	979-06153
10	0.75	Silicone (Si)	18/30 RZ 1/750 Si	979-06158
14	0.75	Silicone (Si)	18/30 RZ 1/750 Si	979-06159
10	1	Silicone (Si)	18/30 RZ 1/1000-Si	979-06164
14	1	Silicone (Si)	18/30 RZ 1/1000-Si	979-06165
10	1.5	Silicone (Si)	18/30 RZ 1/1500-Si	979-06170
14	1.5	Silicone (Si)	18/30 RZ 1/1500-Si	979-06171
10	2	Silicone (Si)	18/30 RZ 1/2000-Si	979-06176
14	2	Silicone (Si)	18/30 RZ 1/2000-Si	979-06177
<hr/>				
10	0.25	Brass. chrome-plated (MSC)	18/30 RZ 1/250-MSC	979-06144
14	0.25	Brass. chrome-plated (MSC)	18/30 RZ 1/250-MSC	979-06145
10	0.5	Brass. chrome-plated (MSC)	18/30 RZ 1/500-MSC	979-06150
14	0.5	Brass. chrome-plated (MSC)	18/30 RZ 1/500-MSC	979-06151
10	0.75	Brass. chrome-plated (MSC)	18/30 RZ 1/750-MSC	979-06156
14	0.75	Brass. chrome-plated (MSC)	18/30 RZ 1/750-MSC	978-06157
10	1	Brass. chrome-plated (MSC)	18/30 RZ 1/1000-MSC	979-06162
14	1	Brass. chrome-plated (MSC)	18/30 RZ 1/1000-MSC	979-06163
10	1.5	Brass. chrome-plated (MSC)	18/30 RZ 1/1500-MSC	979-06168
14	1.5	Brass. chrome-plated (MSC)	18/30 RZ 1/1500-MSC	979-06169
10	2	Brass. chrome-plated (MSC)	18/30 RZ 1/2000-MSC	979-06174
14	2	Brass. chrome-plated (MSC)	18/30 RZ 1/2000-MSC	979-06175

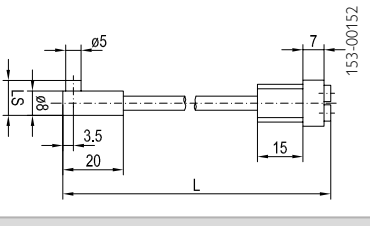

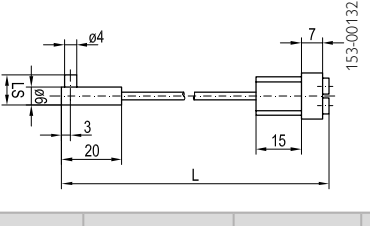

# Fibre-optic cables – standard

18/30 RZ 2/...-Si fibre-optic cable				Highlights						
				<ul style="list-style-type: none"> <li>• Photoelectric diffuse sensor</li> <li>• Silicone, metal or PVC sheath</li> <li>• Straight light exit</li> <li>• Robust design</li> <li>• -20 ... +80°C / +160 °C</li> <li>• Fixing via mounting block MB 8 (MSC/Si) (Article number 903-05141)</li> <li>• Fixing via mounting block MB 6 (PVC) (Article number 903-05139)</li> <li>• For FMS devices</li> </ul>						
18/30 RZ 2/...-MSC fibre-optic cable										
										
18/30 RZ 2/...-PVC fibre-optic cable										
										
Fibre arrangement	FMS 18 typ. scanning distance/range (mm)	FMS 30 typ. scanning distance/range (mm)	Core fibre Ø (mm) material	Sheath material	Ambient temperature (rigid installation)	Bending radius (mm)	Cable length (m)	Collar bushing Ø (mm)	LS (mm)	
Straight	50	60	2 x 1.0 (Si/MSC) 1 x 1.5 (PVC) Glass	See Selection Table	-20 ... +160 °C (Si/MSC) -20 ... +80 °C (PVC)	8	See Selection Table	8 = (Si/MSC) 6 = (PVC)	See Selection Table	

LS (mm)	Length (m)	Sheath material	Part number	Article number
10	0.25	Silicone (Si)	18/30 RZ 2/250-Si	979-06182
14	0.25	Silicone (Si)	18/30 RZ 2/250-Si	979-06183
10	0.5	Silicone (Si)	18/30 RZ 2/500-Si	979-06188
14	0.5	Silicone (Si)	18/30 RZ 2/500-Si	979-06189
10	0.75	Silicone (Si)	18/30 RZ 2/750-Si	979-06194
14	0.75	Silicone (Si)	18/30 RZ 2/750-Si	979-06195
10	1	Silicone (Si)	18/30 RZ 2/1000-Si	979-06200
14	1	Silicone (Si)	18/30 RZ 2/1000-Si	979-06201
10	1.5	Silicone (Si)	18/30 RZ 2/1500-Si	979-06206
14	1.5	Silicone (Si)	18/30 RZ 2/1500-Si	979-06207
10	2	Silicone (Si)	18/30 RZ 2/2000-Si	979-06212
14	2	Silicone (Si)	18/30 RZ 2/2000-Si	979-06213

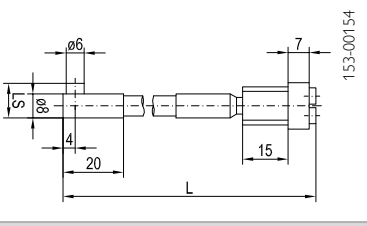
LS (mm)	Length (m)	Sheath material	Part number	Article number
10	0.25	Brass, chrome-plated (MSC)	18/30 RZ 2/250-MSC	979-06180
14	0.25	Brass, chrome-plated (MSC)	18/30 RZ 2/250-MSC	979-06181
10	0.5	Brass, chrome-plated (MSC)	18/30 RZ 2/500-MSC	979-06186
14	0.5	Brass, chrome-plated (MSC)	18/30 RZ 2/500-MSC	979-06187
10	0.75	Brass, chrome-plated (MSC)	18/30 RZ 2/750-MSC	979-06192
14	0.75	Brass, chrome-plated (MSC)	18/30 RZ 2/750-MSC	979-06193
10	1	Brass, chrome-plated (MSC)	18/30 RZ 2/1000-MSC	979-06198
14	1	Brass, chrome-plated (MSC)	18/30 RZ 2/1000-MSC	979-06199
10	1.5	Brass, chrome-plated (MSC)	18/30 RZ 2/1500-MSC	979-06204
14	1.5	Brass, chrome-plated (MSC)	18/30 RZ 2/1500-MSC	979-06205
10	2	Brass, chrome-plated (MSC)	18/30 RZ 2/2000-MSC	979-06210
14	2	Brass, chrome-plated (MSC)	18/30 RZ 2/2000-MSC	979-06211
10	0.25	PVC	18/30 RZ 2/250-PVC	979-06178
14	0.25	PVC	18/30 RZ 2/250-PVC	979-06179
10	0.5	PVC	18/30 RZ 2/500-PVC	979-06184
14	0.5	PVC	18/30 RZ 2/500-PVC	979-06185
10	0.75	PVC	18/30 RZ 2/750-PVC	979-06190
14	0.75	PVC	18/30 RZ 2/750-PVC	979-06191
10	1	PVC	18/30 RZ 2/1000-PVC	979-06196
14	1	PVC	18/30 RZ 2/1000-PVC	979-06197
10	1.5	PVC	18/30 RZ 2/1500-PVC	979-06202
14	1.5	PVC	18/30 RZ 2/1500-PVC	979-06203
10	2	PVC	18/30 RZ 2/2000-PVC	979-06208
14	2	PVC	18/30 RZ 2/2000-PVC	979-06209

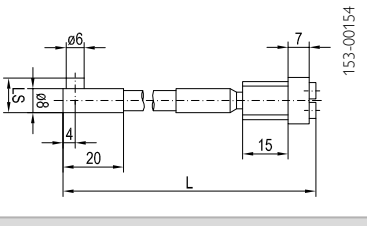

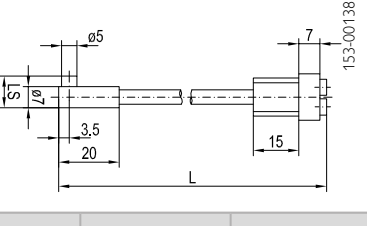
# Fibre-optic cables – standard

18/30 RZ 3/...-Si fibre-optic cable				Highlights					
				<ul style="list-style-type: none"> <li>• Photoelectric diffuse sensor</li> <li>• Silicone, metal or PVC sheath</li> <li>• Straight light exit</li> <li>• Robust design</li> <li>• -20 ... +80°C / +160 °C</li> <li>• Fixing via mounting block MB 8 (Si/MSC) (Article number 903-05141)</li> <li>• Fixing via mounting block MB 7 (PVC) (Article number 903-05140)</li> <li>• For FMS devices</li> </ul>					
18/30 RZ 3/...-MSC fibre-optic cable									
									
18/30 RZ 3/...-PVC fibre-optic cable									
									
Fibre arrangement	FMS 18 typ. scanning distance/range (mm)	FMS 30 typ. scanning distance/range (mm)	Core fibre Ø (mm) material	Sheath material	Ambient temperature (rigid installation)	Bending radius (mm)	Cable length (m)	Collar bushing Ø (mm)	LS (mm)
Straight	160	200	2 x 2.0 (Si/MSC) 1 x 2.8 (PVC) Glass	See Selection Table	-20 ... +160 °C (Si/MSC) -20 ... +80 °C (PVC)	25 = (Si/MSC) 35 = (PVC)	See Selection Table	8 = (Si/MSC) 7 = (PVC)	See Selection Table

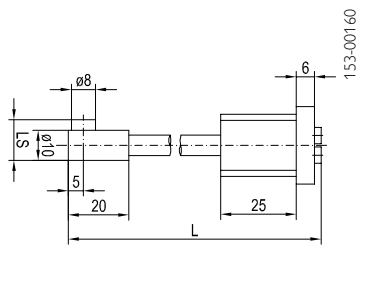

LS (mm)	Length (m)	Sheath material	Part number	Article number
10	0.25	Silicone (Si)	18/30 RZ 3/250 Si	979-06218
14	0.25	Silicone (Si)	18/30 RZ 3/250 Si	979-06219
10	0.5	Silicone (Si)	18/30 RZ 3/500 Si	979-06224
14	0.5	Silicone (Si)	18/30 RZ 3/500 Si	979-06225
10	0.75	Silicone (Si)	18/30 RZ 3/750-Si	979-06230
14	0.75	Silicone (Si)	18/30 RZ 3/750-Si	979-06231
10	1	Silicone (Si)	18/30 RZ 3/1000 Si	979-06236
14	1	Silicone (Si)	18/30 RZ 3/1000 Si	979-06237
10	1.5	Silicone (Si)	18/30 RZ 3/1500-Si	979-06242
14	1.5	Silicone (Si)	18/30 RZ 3/1500-Si	979-06243
10	2	Silicone (Si)	18/30 RZ 3/2000-Si	979-06248
14	2	Silicone (Si)	18/30 RZ 3/2000-Si	979-06249

LS (mm)	Length (m)	Sheath material	Part number	Article number
10	0.25	Brass, chrome-plated (MSC)	18/30 RZ 3/250-MSC	979-06216
14	0.25	Brass, chrome-plated (MSC)	18/30 RZ 3/250-MSC	979-06217
10	0.5	Brass, chrome-plated (MSC)	18/30 RZ 3/500-MSC	979-06222
14	0.5	Brass, chrome-plated (MSC)	18/30 RZ 3/500-MSC	979-06223
10	0.75	Brass, chrome-plated (MSC)	18/30 RZ 3/750-MSC	979-06228
14	0.75	Brass, chrome-plated (MSC)	18/30 RZ 3/750-MSC	979-06229
10	1	Brass, chrome-plated (MSC)	18/30 RZ 3/1000-MSC	979-06234
14	1	Brass, chrome-plated (MSC)	18/30 RZ 3/1000-MSC	979-06235
10	1.5	Brass, chrome-plated (MSC)	18/30 RZ 3/1500-MSC	979-06240
14	1.5	Brass, chrome-plated (MSC)	18/30 RZ 3/1500-MSC	979-06241
10	2	Brass, chrome-plated (MSC)	18/30 RZ 3/2000-MSC	979-06246
14	2	Brass, chrome-plated (MSC)	18/30 RZ 3/2000-MSC	979-06247
10	0.25	PVC	18/30 RZ 3/250-PVC	979-06214
14	0.25	PVC	18/30 RZ 3/250-PVC	979-06215
10	0.5	PVC	18/30 RZ 3/500-PVC	979-06220
14	0.5	PVC	18/30 RZ 3/500-PVC	979-06221
10	0.75	PVC	18/30 RZ 3/750-PVC	979-06226
14	0.75	PVC	18/30 RZ 3/750-PVC	979-06227
10	1	PVC	18/30 RZ 3/1000-PVC	979-06232
14	1	PVC	18/30 RZ 3/1000-PVC	979-06233
10	1.5	PVC	18/30 RZ 3/1500-PVC	979-06238
14	1.5	PVC	18/30 RZ 3/1500-PVC	979-06239
10	2	PVC	18/30 RZ 3/2000-PVC	979-06244
14	2	PVC	18/30 RZ 3/2000-PVC	979-06245

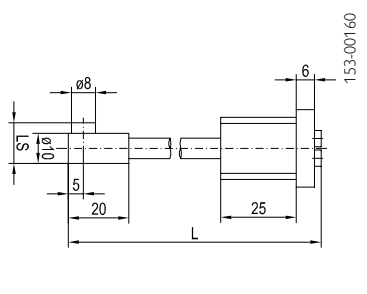
# Fibre-optic cables – standard

30 RZ 4/...-Si fibre-optic cable				Highlights					
				<ul style="list-style-type: none"> <li>• Photoelectric diffuse sensor</li> <li>• Silicone or metal sheath</li> <li>• Straight light exit</li> <li>• Robust design</li> <li>• -20 ... +160 °C</li> <li>• Fixing via mounting block MB 10 (Article number 903-05142)</li> <li>• For FMS-30 devices</li> </ul>					
30 RZ 4/...-MSC fibre-optic cable									
									
Fibre arrangement	FMS 18 typ. scanning distance/range (mm)	FMS 30 typ. scanning distance/range (mm)	Core fibre Ø (mm) material	Sheath material	Ambient temperature (rigid installation)	Bending radius (mm)	Cable length (m)	Collar bushing Ø (mm)	LS (mm)
Straight	–	400	2 x 2.3 Glass	See Selection Table	-20 ... +160 °C	25	See Selection Table	10	See Selection Table

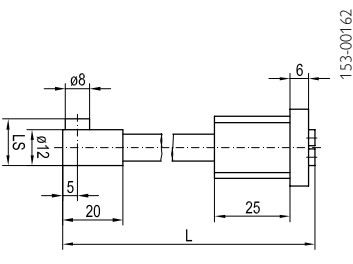
LS (mm)	Length (m)	Sheath material	Part number	Article number
16	0.25	Silicone (Si)	30 RZ 4/250-Si	979-06252
20	0.25	Silicone (Si)	30 RZ 4/250-Si	979-06253
16	0.5	Silicone (Si)	30 RZ 4/500-Si	979-06256
20	0.5	Silicone (Si)	30 RZ 4/500-Si	979-06257
16	0.75	Silicone (Si)	30 RZ 4/750-Si	979-06260
20	0.75	Silicone (Si)	30 RZ 4/750-Si	979-06261
16	1	Silicone (Si)	30 RZ 4/1000-Si	979-06264
20	1	Silicone (Si)	30 RZ 4/1000-Si	979-06265
16	1.5	Silicone (Si)	30 RZ 4/1500-Si	979-06268
20	1.5	Silicone (Si)	30 RZ 4/1500-Si	979-06269
16	2	Silicone (Si)	30 RZ 4/2000-Si	979-06272
20	2	Silicone (Si)	30 RZ 4/2000-Si	979-06273
16	0.25	Brass, chrome-plated (MSC)	30 RZ 4/250-MSC	979-06250
20	0.25	Brass, chrome-plated (MSC)	30 RZ 4/250-MSC	979-06251
16	0.5	Brass, chrome-plated (MSC)	30 RZ 4/500-MSC	979-06254
20	0.5	Brass, chrome-plated (MSC)	30 RZ 4/500-MSC	979-06255
16	0.75	Brass, chrome-plated (MSC)	30 RZ 4/750-MSC	979-06258
20	0.75	Brass, chrome-plated (MSC)	30 RZ 4/750-MSC	979-06259
16	1	Brass, chrome-plated (MSC)	30 RZ 4/1000-MSC	979-06262
20	1	Brass, chrome-plated (MSC)	30 RZ 4/1000-MSC	979-06263
16	1.5	Brass, chrome-plated (MSC)	30 RZ 4/1500-MSC	979-06266
20	1.5	Brass, chrome-plated (MSC)	30 RZ 4/1500-MSC	979-06267
16	2	Brass, chrome-plated (MSC)	30 RZ 4/2000-MSC	979-06270
20	2	Brass, chrome-plated (MSC)	30 RZ 4/2000-MSC	979-06271

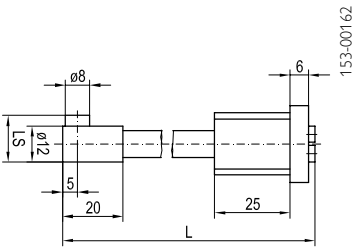
30 RZ 12/...-Si fibre-optic cable				Highlights						
				<ul style="list-style-type: none"> <li>• Photoelectric diffuse sensor</li> <li>• Silicone or metal sheath</li> <li>• Straight light exit</li> <li>• Robust design</li> <li>• -20 ... +160 °C</li> <li>• Fixing via mounting block MB 10 (Article number 903-05142)</li> <li>• For FMS-30 devices</li> </ul>						
30 RZ 12/...-MSC fibre-optic cable										
										
Fibre arrangement	FMS 18 typ. scanning distance/range (mm)	FMS 30 typ. scanning distance/range (mm)	Core fibre Ø (mm) material	Sheath material	Ambient temperature (rigid installation)	Bending radius (mm)	Cable length (m)	Collar bushing Ø (mm)	LS (mm)	
Straight	–	800	2 x 3.5 Glass	See Selection Table	-20 ... +160 °C	45	See Selection Table	12	See Selection Table	





LS (mm)	Length (m)	Sheath material	Part number	Article number
16	0.25	Silicone (Si)	30 RZ 12/250-Si	979-06308
20	0.25	Silicone (Si)	30 RZ 12/250-Si	979-06309
16	0.5	Silicone (Si)	30 RZ 12/500-Si	979-06312
20	0.5	Silicone (Si)	30 RZ 12/500-Si	979-06313
16	0.75	Silicone (Si)	30 RZ 12/750-Si	979-06316
20	0.75	Silicone (Si)	30 RZ 12/750-Si	979-06317
16	1	Silicone (Si)	30 RZ 12/1000-Si	979-06320
20	1	Silicone (Si)	30 RZ 12/1000-Si	979-06321
16	1.5	Silicone (Si)	30 RZ 12/1500-Si	979-06324
20	1.5	Silicone (Si)	30 RZ 12/1500-Si	979-06325
16	2	Silicone (Si)	30 RZ 12/2000-Si	979-06328
20	2	Silicone (Si)	30 RZ 12/2000-Si	979-06329
<hr/>				
16	0.25	Stainless steel (V2A chrome plated)	30 RZ 12/250-MSC	979-06306
20	0.25	Stainless steel (V2A chrome plated)	30 RZ 12/250-MSC	979-06307
16	0.5	Stainless steel (V2A chrome plated)	30 RZ 12/500-MSC	979-06310
20	0.5	Stainless steel (V2A chrome plated)	30 RZ 12/500-MSC	979-06311
16	0.75	Stainless steel (V2A chrome plated)	30 RZ 12/750-MSC	979-06314
20	0.75	Stainless steel (V2A chrome plated)	30 RZ 12/750-MSC	979-06315
16	1	Stainless steel (V2A chrome plated)	30 RZ 12/1000-MSC	979-06318
20	1	Stainless steel (V2A chrome plated)	30 RZ 12/1000-MSC	979-06319
16	1.5	Stainless steel (V2A chrome plated)	30 RZ 12/1500-MSC	979-06322
20	1.5	Stainless steel (V2A chrome plated)	30 RZ 12/1500-MSC	979-06323
16	2	Stainless steel (V2A chrome plated)	30 RZ 12/2000-MSC	979-06326
20	2	Stainless steel (V2A chrome plated)	30 RZ 12/2000-MSC	979-06327





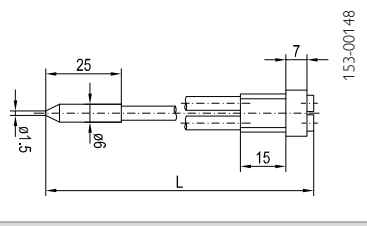

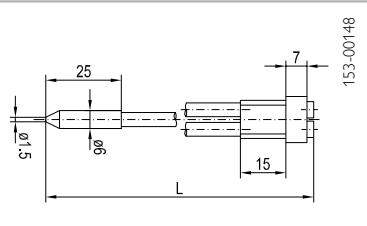
# Fibre-optic cables – standard

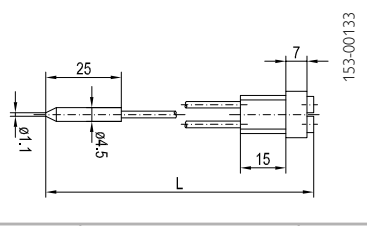
18/30 L 1/...-Si fibre-optic cable		Highlights										
		<ul style="list-style-type: none"> <li>• Through-beam photoelectric sensor</li> <li>• Silicone, metal or PVC sheath</li> <li>• Small right-angle light exit</li> <li>• Robust design</li> <li>• -20 ... +80 °C / +160 °C (PVC)/(Si/MS)</li> <li>• Fixing via mounting block MB 6 (MSC/Si) (Article number 903-05139)</li> <li>• Fixing via mounting block MB 4.5 (PVC) (Article number 903-50314)</li> <li>• For FMS devices</li> </ul>										
18/30 L 1/...-MSC fibre-optic cable												
18/30 L 1/...-PVC fibre-optic cable												
Fibre arrangement	FMS 18 typ. scanning distance/range (mm)	FMS 30 typ. scanning distance/range (mm)	Core fibre Ø (mm) (T=Transmitter; R=Receiver) Material	Sheath material	Ambient temperature (rigid installation)	Bending radius (mm)	Cable length (m)	Collar bushing Ø (mm)	LS (mm)			
Right-angle	80	100	1 x 0.8 (T) / 1 x 0.8 (R) (Si/MS) 1 x 1.0 (T) / 1 x 1.0 (R) (PVC) Glass	See Selection Table	-20 ... +160 °C	15	See Selection Table	6	-			

Length (m)	Sheath material	Part number	Article number
0.25	Silicone (Si)	18/30 L 1/250-Si	978-08230
0.5	Silicone (Si)	18/30 L 1/500-Si	978-08231
0.75	Silicone (Si)	18/30 L 1/750-Si	978-08567
1	Silicone (Si)	18/30 L 1/1000-Si	978-08232
1.5	Silicone (Si)	18/30 L 1/1500-Si	978-08568
2	Silicone (Si)	18/30 L 1/2000-Si	978-08233
0.25	Brass, chrome-plated (MSC)	18/30 L 1/250-MSC	978-08206
0.5	Brass, chrome-plated (MSC)	18/30 L 1/500-MSC	978-08207
0.75	Brass, chrome-plated (MSC)	18/30 L 1/750-MSC	978-08547
1	Brass, chrome-plated (MSC)	18/30 L 1/1000-MSC	978-08208
1.5	Brass, chrome-plated (MSC)	18/30 L 1/1500-MSC	978-08548
2	Brass, chrome-plated (MSC)	18/30 L 1/2000-MSC	978-08209
0.25	PVC	18/30 L 1/250-PVC	978-08193
0.5	PVC	18/30 L 1/500-PVC	978-08194
0.75	PVC	18/30 L 1/750-PVC	978-08541
1	PVC	18/30 L 1/1000-PVC	978-08195
1.5	PVC	18/30 L 1/1500-PVC	978-08542
2	PVC	18/30 L 1/2000-PVC	978-08196

18/30 L 2/...-Si fibre-optic cable		Highlights							
		<ul style="list-style-type: none"> <li>• Through-beam photoelectric sensor</li> <li>• Silicone, metal or PVC sheath</li> <li>• Right-angle light exit</li> <li>• Robust design</li> <li>• -20 ... +80 °C / +160 °C (PVC)/(Si/MSC)</li> <li>• Fixing via mounting block MB 8 (MSC/Si) (Article number 903-05141)</li> <li>• Fixing via mounting block MB 3.5 (PVC) (Article number 903-50313)</li> <li>• For FMS devices</li> </ul>							
18/30 L 2/...-MSC fibre-optic cable									
18/30 L 2/...-PVC fibre-optic cable		<ul style="list-style-type: none"> <li>• For FMS devices</li> </ul>							
Fibre arrangement	FMS 18 typ. scanning distance/range (mm)	FMS 30 typ. scanning distance/range (mm)	Core fibre Ø (mm) (T=Transmitter; R=Receiver) Material	Sheath material	Ambient temperature (rigid installation)	Bending radius (mm)	Cable length (m)	Collar bushing Ø (mm)	LS (mm)
Right-angle	360	400	1 x 1.6 (T) / 1 x 1.6 (R) (Si/MSC) 1 x 1.5 (T) / 1 x 1.5 (R) (PVC) Glass	See Selection Table	-20 ... +160 °C (Si/MSC) -20 ... +80 °C (PVC)	20 = (Si/MSC) 15 = (PVC)	See Selection Table	8 = (Si/MSC) 3.5 = (PVC)	-

Length (m)	Sheath material	Part number	Article number
0.25	Silicone (Si)	18/30 L 2/250-Si	978-08238
0.5	Silicone (Si)	18/30 L 2/500-Si	978-08239
0.75	Silicone (Si)	18/30 L 2/750-Si	978-08571
1	Silicone (Si)	18/30 L 2/1000-Si	978-08240
1.5	Silicone (Si)	18/30 L 2/1500-Si	978-08572
2	Silicone (Si)	18/30 L 2/2000-Si	978-08241
0.25	Brass, chrome-plated (MSC)	18/30 L 2/250-MSC	978-08210
0.5	Brass, chrome-plated (MSC)	18/30 L 2/500-MSC	978-08211
0.75	Brass, chrome-plated (MSC)	18/30 L 2/750-MSC	978-08549
1	Brass, chrome-plated (MSC)	18/30 L 2/1000-MSC	978-08212
1.5	Brass, chrome-plated (MSC)	18/30 L 2/1500-MSC	978-08550
2	Brass, chrome-plated (MSC)	18/30 L 2/2000-MSC	978-08213
0.25	PVC	18/30 L 2/250-PVC	978-08197
0.5	PVC	18/30 L 2/500-PVC	978-08198
0.75	PVC	18/30 L 2/750-PVC	978-08543
1	PVC	18/30 L 2/1000-PVC	978-08199
1.5	PVC	18/30 L 2/1500-PVC	978-08544
2	PVC	18/30 L 2/2000-PVC	978-08200

# Fibre-optic cables – standard

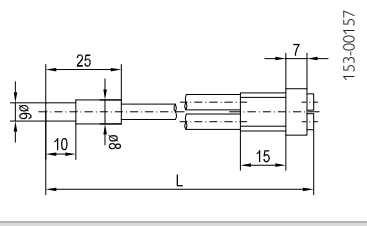
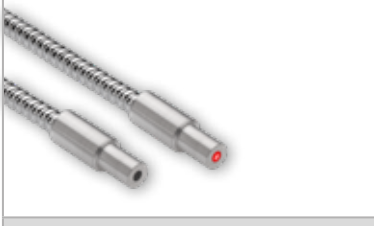
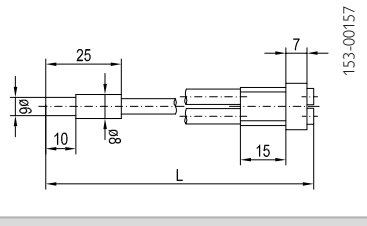
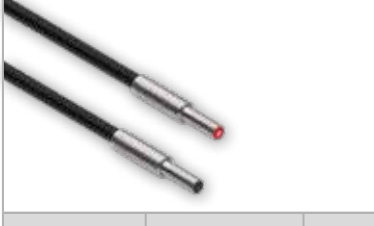
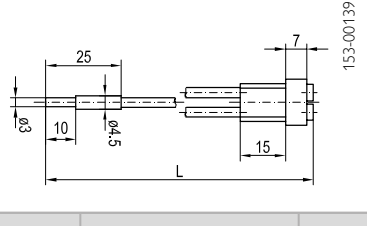

18/30 L 3/...-Si fibre-optic cable		Highlights									
		<ul style="list-style-type: none"> <li>• Through-beam photoelectric sensor</li> <li>• Silicone, metal or PVC sheath</li> <li>• Right-angle light exit</li> <li>• Robust design</li> <li>• -20 ... +80°C / +160 °C</li> <li>• Fixing via mounting block MB 8 (MSC/Si) (Article number 903-05141)</li> <li>• Fixing via mounting block MB 4.5 (PVC) (Article number 903-50314)</li> <li>• For FMS devices</li> </ul>									
18/30 L 3/...-MSC fibre-optic cable											
18/30 L 3/...-PVC fibre-optic cable											
Fibre arrangement	FMS 18 typ. scanning distance/range (mm)	FMS 30 typ. scanning distance/range (mm)	Core fibre Ø (mm) (T=Transmitter; R=Receiver) Material	Sheath material	Ambient temperature (rigid installation)	Bending radius (mm)	Cable length (m)	Collar bushing Ø (mm)	LS (mm)		
Right-angle	700	1000	1 x 2.0 (T) / 1 x 2.0 (R) Glass	See Selection Table	-20 ... +160 °C (Si/MSC) -20 ... +80 °C (PVC)	20	See Selection Table	8 = (Si/MSC) 4.5 = (PVC)	-		

Length (m)	Sheath material	Part number	Article number
0.25	Silicone (Si)	18/30 L 3/250-Si	978-08242
0.5	Silicone (Si)	18/30 L 3/500-Si	978-08243
0.75	Silicone (Si)	18/30 L 3/750-Si	978-08573
1	Silicone (Si)	18/30 L 3/1000-Si	978-08244
1.5	Silicone (Si)	18/30 L 3/1500-Si	978-08574
2	Silicone (Si)	18/30 L 3/2000-Si	978-08245
0.25	Brass, chrome-plated (MSC)	18/30 L 3/250-MSC	978-08214
0.5	Brass, chrome-plated (MSC)	18/30 L 3/500-MSC	978-08215
0.75	Brass, chrome-plated (MSC)	18/30 L 3/750-MSC	978-08551
1	Brass, chrome-plated (MSC)	18/30 L 3/1000-MSC	978-08216
1.5	Brass, chrome-plated (MSC)	18/30 L 3/1500-MSC	978-08552
2	Brass, chrome-plated (MSC)	18/30 L 3/2000-MSC	978-08217
0.25	PVC	18/30 L 3/250-PVC	978-08201
0.5	PVC	18/30 L 3/500-PVC	978-08202
0.75	PVC	18/30 L 3/750-PVC	978-08545
1	PVC	18/30 L 3/1000-PVC	978-08203
1.5	PVC	18/30 L 3/1500-PVC	978-08546
2	PVC	18/30 L 3/2000-PVC	978-08204

30 L 4/...-Si fibre-optic cable				Highlights						
				<ul style="list-style-type: none"> <li>• Through-beam photoelectric sensor</li> <li>• Silicone or metal sheath</li> <li>• Right-angle light exit</li> <li>• Long range</li> <li>• Robust design</li> <li>• -20 ... +160 °C</li> <li>• Fixing via mounting block MB 10 (Article number 903-05142)</li> <li>• For FMS-30 devices</li> </ul>						
30 L 4/...-MSC fibre-optic cable										
Fibre arrangement	FMS 18 typ. scanning distance/range (mm)	FMS 30 typ. scanning distance/range (mm)	Core fibre Ø (mm) (T=Transmitter; R=Receiver) Material	Sheath material	Ambient temperature (rigid installation)	Bending radius (mm)	Cable length (m)	Collar bushing Ø (mm)	LS (mm)	
Right-angle	–	3000	1 x 2.3 (T) / 1 x 2.3 (R) Glass	See Selection Table	-20 ... +160 °C	25	See Selection Table	10	–	

Length (m)	Sheath material	Part number	Article number
0.25	Silicone (Si)	30 L 4/250-Si	978-06932
0.5	Silicone (Si)	30 L 4/500-Si	978-06933
0.75	Silicone (Si)	30 L 4/750-Si	978-08575
1	Silicone (Si)	30 L 4/1000-Si	978-06934
1.5	Silicone (Si)	30 L 4/1500-Si	978-08576
2	Silicone (Si)	30 L 4/2000-Si	978-06935
0.25	Brass. chrome-plated (MSC)	30 L 4/250-MSC	978-06650
0.5	Brass. chrome-plated (MSC)	30 L 4/500-MSC	978-06651
0.75	Brass. chrome-plated (MSC)	30 L 4/750-MSC	978-08553
1	Brass. chrome-plated (MSC)	30 L 4/1000-MSC	978-06652
1.5	Brass. chrome-plated (MSC)	30 L 4/1500-MSC	978-08554
2	Brass. chrome-plated (MSC)	30 L 4/2000-MSC	978-06653

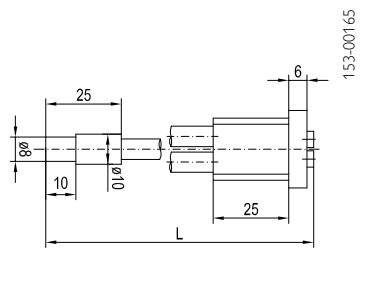
# Fibre-optic cables – standard

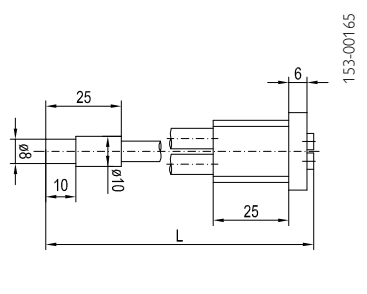
30 L 12/...-Si fibre-optic cable				Highlights									
				<ul style="list-style-type: none"> <li>• Through-beam photoelectric sensor</li> <li>• Silicone or metal sheath</li> <li>• Right-angle light exit</li> <li>• Extremely insensitive to contamination</li> <li>• Long scanning distance/range</li> <li>• Robust design</li> <li>• -20 ... +160 °C</li> <li>• Fixing via mounting block MB 10 (Article number 903-05142)</li> <li>• For FMS-30 devices</li> </ul>									
30 L 12/...-MSC fibre-optic cable													
Fibre arrangement	FMS 18 typ. scanning distance/range (mm)	FMS 30 typ. scanning distance/range (mm)	Core fibre Ø (mm) (T=Transmitter; R=Receiver) Material	Sheath material	Ambient temperature (rigid installation)	Bending radius (mm)	Cable length (m)	Collar bushing Ø (mm)	LS (mm)				
Right-angle	–	4800	1 × 3.5 (T) / 1 × 3.5 (R) Glass	See Selection Table	-20 ... +160 °C	25	See Selection Table	12	–				

Length (m)	Sheath material	Part number	Article number
0.25	Silicone (Si)	30 L 12/250-Si	978-06948
0.5	Silicone (Si)	30 L 12/500-Si	978-06949
0.75	Silicone (Si)	30 L 12/750-Si	978-08577
1	Silicone (Si)	30 L 12/1000-Si	978-06950
1.5	Silicone (Si)	30 L 12/1500-Si	978-08578
2	Silicone (Si)	30 L 12/2000-Si	978-06951
0.25	Brass, chrome-plated (MSC)	30 L 12/250-MSC	978-06797
0.5	Brass, chrome-plated (MSC)	30 L 12/500-MSC	978-06798
0.75	Brass, chrome-plated (MSC)	30 L 12/750-MSC	978-08555
1	Brass, chrome-plated (MSC)	30 L 12/1000-MSC	978-06799
1.5	Brass, chrome-plated (MSC)	30 L 12/1500-MSC	978-08556
2	Brass, chrome-plated (MSC)	30 L 12/2000-MSC	978-06800

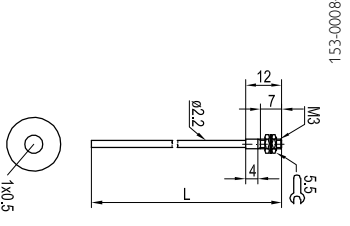
K2L-201 fibre-optic cable						Highlights					
						<ul style="list-style-type: none"> <li>• Through-beam photoelectric sensor</li> <li>• Small installation dimensions</li> <li>• Suitable for ancillary optics for range expansion</li> <li>• Fibre length individually cuttable</li> <li>• For FL 70/FL 20 devices</li> </ul>					
Design Light exit	FL 70 typ. scanning distance (mm) Standard / Fine / High	FL 20 typ. scanning distance (mm) Default setting	Fibre arrangement	Suitable for ancillary lens	Core fibre Ø (mm) (T = Transmitter; R = Receiver) Material	Sheath material	Ambient temperature (rigid installation)	Fibre bending radius (mm)	Cable length	Collar bushing	LS (mm)
Mono/ right-angle	120 / 60 / 200	–	See drawing	LVL6-M3	1 x 0.5 (T) 1 x 0.5 (R) PMMA	Polyethylene (PE)	-40 ... +70 °C	25	2 m Cuttable	M3 Stainless steel	–

Part number	Article number
K2L-201	721-50771

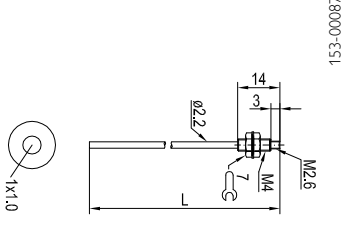
K2L-202 fibre-optic cable						Highlights					
						<ul style="list-style-type: none"> <li>• Through-beam photoelectric sensor</li> <li>• Short mounting sleeve</li> <li>• Suitable for ancillary optics for range expansion</li> <li>• Fibre length individually cuttable</li> <li>• For FL 70/FL 20 devices</li> </ul>					
Design Light exit	FL 70 typ. scanning distance (mm) Standard / Fine / High	FL 20 typ. scanning distance (mm) Default setting	Fibre arrangement	Suitable for ancillary lens	Core fibre Ø (mm) (T = Transmitter; R = Receiver) Material	Sheath material	Ambient temperature (rigid installation)	Fibre bending radius (mm)	Cable length	Collar bushing	LS (mm)
Mono/ right-angle	350 / 200 / 800	180	See drawing	LVL6-M4	1 x 1.0 (T) 1 x 1.0 (R) PMMA	Polyethylene (PE)	-40 ... +70 °C	25	2 m Cuttable	M4 Stainless steel	–

Part number	Article number
K2L-202	721-50772

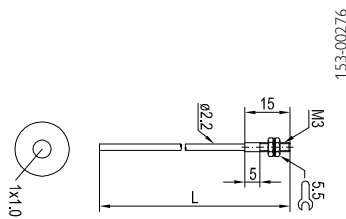

# Fibre-optic cables – standard

K2L-7 fibre-optic cable						Highlights					
						<ul style="list-style-type: none"> <li>• Through-beam photoelectric sensor</li> <li>• Small installation dimensions</li> <li>• Suitable for ancillary optics for range expansion</li> <li>• Fibre length individually cuttable</li> <li>• For FL 70/FL 20 devices</li> </ul>					
Design Light exit	FL 70 typ. scanning distance (mm) Standard / Fine / High	FL 20 typ. scanning distance (mm) Default setting	Fibre arrangement	Suitable for ancillary lens	Core fibre Ø (mm) (T = Transmitter; R = Receiver) Material	Sheath material	Ambient temperature (rigid installation)	Fibre bending radius (mm)	Cable length	Collar bushing	LS (mm)
Mono/ right-angle	350 / 220 / 810	180	See drawing	LVL6-M3	1 x 1.0 (T) 1 x 1.0 (R) PMMA	Polyethylene (PE)	-40 ... +70 °C	25	2 m Cuttable	M3 Brass, nickel-plated	–

Part number	Article number
K2L-7	840-11000

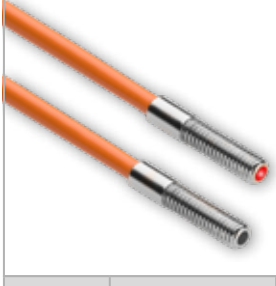
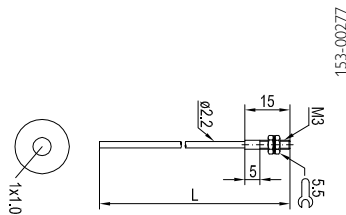
K2L-77 fibre-optic cable						Highlights					
						<ul style="list-style-type: none"> <li>• Through-beam photoelectric sensor</li> <li>• Oil-resistant</li> <li>• Expanded temperature range</li> <li>• Suitable for ancillary optics for range expansion</li> <li>• Fibre length individually cuttable</li> <li>• For FL 70/FL 20 devices</li> </ul>					
Design Light exit	FL 70 typ. scanning distance (mm) Standard / Fine / High	FL 20 typ. scanning distance (mm) Default setting	Fibre arrangement	Suitable for ancillary lens	Core fibre Ø (mm) (T = Transmitter; R = Receiver) Material	Sheath material	Ambient temperature (rigid installation)	Fibre bending radius (mm)	Cable length	Collar bushing	LS (mm)
Mono/ right-angle	270 / 145 / 550	140	See drawing	LVL6-M3	1 x 1.0 (T) 1 x 1.0 (R) PMMA	Polyamid (PA)	-55 ... +85 °C	2	2 m Cuttable	M3 Brass, nickel-plated	–

Part number	Article number
K2L-77	840-11001

LLK2LM3-PE-1m fibre-optic cable						Highlights					
						<ul style="list-style-type: none"> <li>• Through-beam photoelectric sensor</li> <li>• Stainless steel head with very small head diameter</li> <li>• Suitable for ancillary optics for range expansion</li> <li>• Fibre length individually cuttable</li> <li>• For FL 70/FL 20 devices</li> </ul>					
Design Light exit	FL 70 typ. scanning distance (mm) Standard / Fine / High	FL 20 typ. scanning distance (mm) Default setting	Fibre arrangement	Suitable for ancillary lens	Core fibre Ø (mm) (T = Transmitter; R = Receiver) Material	Sheath material	Ambient temperature (rigid installation)	Fibre bending radius (mm)	Cable length	Collar bushing	LS (mm)
Mono/ right-angle	150 / 60 / 240	80	See drawing	LVLf6-M3	1 x 0.5 (T) 1 x 0.5 (R) PMMA	Polyethylene (PE)	-40 ... +60 °C	25	1 m Cutable	M3 Stainless steel	–

Part number	Article number
LLK2LM3-PE-1m	750-11000

LLK2LM4-PE-1m fibre-optic cable						Highlights					
						<ul style="list-style-type: none"> <li>• Through-beam photoelectric sensor</li> <li>• Suitable for ancillary optics for range expansion</li> <li>• Fibre length individually cuttable</li> <li>• For FL 70/FL 20 devices</li> </ul>					
Design Light exit	FL 70 typ. scanning distance (mm) Standard / Fine / High	FL 20 typ. scanning distance (mm) Default setting	Fibre arrangement	Suitable for ancillary lens	Core fibre Ø (mm) (T = Transmitter; R = Receiver) Material	Sheath material	Ambient temperature (rigid installation)	Fibre bending radius (mm)	Cable length	Collar bushing	LS (mm)
Mono/ right-angle	400 / 240 / 780	200	See drawing	LVLf6-M4	1 x 1.0 (T) 1 x 1.0 (R) PMMA	Polyethylene (PE)	-40 ... +60 °C	25	1 m Cutable	M4 Stainless steel	–

Part number	Article number
LLK2LM4-PE-1m	750-11001

# Fibre-optic cables – standard

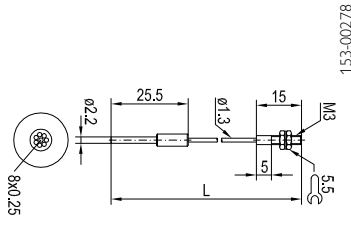
K1L-78 fibre-optic cable						Highlights						
						<ul style="list-style-type: none"> <li>• Through-beam photoelectric sensor</li> <li>• Very small bending radius</li> <li>• Suitable for ancillary optics for range expansion</li> <li>• Fibre length individually cuttable</li> <li>• For FL 70/FL 20 devices</li> </ul>						
Design	Light exit	FL 70 typ. scanning distance (mm) Standard / Fine / High	FL 20 typ. scanning distance (mm) Default setting	Fibre arrangement	Suitable for ancillary lens	Core fibre Ø (mm) (T = Transmitter; R = Receiver) Material	Sheath material	Ambient temperature (rigid installation)	Fibre bending radius (mm)	Cable length	Collar bushing	LS (mm)
Right-angle		200 / 120 / 405	100	See drawing	LVL6-M3	8 x 0.25 (T) 8 x 0.25 (R) PMMA	Polyethylene (PE)	-40 ... +70 °C	3	2 m Cuttable	M3 Brass, nickel-plated	–

Part number	Article number
K1L-78	840-11002

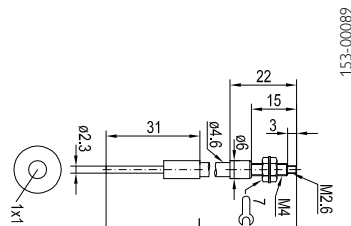

33 L 1/...-MSC fibre-optic cable						Highlights						
						<ul style="list-style-type: none"> <li>• Through-beam photoelectric sensor</li> <li>• Metal sheath</li> <li>• Robust design</li> <li>• -20 ... +160 °C</li> <li>• Suitable for ancillary optics for range expansion</li> <li>• Fixing via mounting block MB 6 (Article number 903-05139)</li> <li>• For FL 70/FL 20 devices</li> </ul>						
Design	Light exit	FL 70 typ. scanning distance (mm) Standard / Fine / High	FL 20 typ. scanning distance (mm) Default setting	Fibre arrangement	Suitable for ancillary lens	Core fibre Ø (mm) (T = Transmitter; R = Receiver) Material	Sheath material	Ambient temperature (rigid installation)	Fibre bending radius (mm)	Cable length	Collar bushing	LS (mm)
Mono/ right-angle		270 / 165 / 550	140	See drawing	LVL6-M4	1 x 1.0 (T) 1 x 1.0 (R) Glass	Brass, chrome-plated (MSC)	-20 ... +160 °C	15	See selection table	M4 Brass, nickel-plated	–

Length (m)	Part number	Article number
0.25	33 L1/250-MSC	978-51650
0.5	33 L1/500-MSC	978-51444
1	33 L1/1000-MSC	978-51657
2	33 L1/2000-MSC	978-51682

18/30 LZ 1/...-Si fibre-optic cable				Highlights						
				<ul style="list-style-type: none"> <li>• Through-beam photoelectric sensor</li> <li>• Silicone or metal sheath</li> <li>• Straight light exit</li> <li>• Robust design</li> <li>• -20 ... +160 °C</li> <li>• Fixing via mounting block MB 6 (Article number 903-05139)</li> <li>• For FMS devices</li> </ul>						
18/30 LZ 1/...-MSC fibre-optic cable										
Fibre arrangement Light exit	FMS 18 typ. scanning distance/range (mm)	FMS 30 typ. scanning distance/range (mm)	Core fibre Ø (mm) (T=Transmitter; R=Receiver) Material	Sheath material	Ambient temperature (rigid installation)	Bending radius (mm)	Cable length (m)	Collar bushing Ø (mm)	LS (mm)	
Straight	80	100	1 x 1.0 (T) / 1 x 1.0 (R) Glass	See Selection Table	-20 ... +160 °C	15	See Selection Table	6	See Selection Table	

LS (mm)	Length (m)	Sheath material	Part number	Article number
10	0.25	Silicone (Si)	18/30 LZ 1/250-Si	978-06366
14	0.25	Silicone (Si)	18/30 LZ 1/250-Si	978-06367
10	0.5	Silicone (Si)	18/30 LZ 1/500-Si	978-06372
14	0.5	Silicone (Si)	18/30 LZ 1/500-Si	978-06373
10	0.75	Silicone (Si)	18/30 LZ 1/750-Si	978-06378
14	0.75	Silicone (Si)	18/30 LZ 1/750-Si	978-06379
10	1	Silicone (Si)	18/30 LZ 1/1000-Si	978-06384
14	1	Silicone (Si)	18/30 LZ 1/1000-Si	978-06385
10	1.5	Silicone (Si)	18/30 LZ 1/1500-Si	978-06390
14	1.5	Silicone (Si)	18/30 LZ 1/1500-Si	978-06391
10	2	Silicone (Si)	18/30 LZ 1/2000-Si	978-06396
14	2	Silicone (Si)	18/30 LZ 1/2000-Si	978-06397
<hr/>				
10	0.25	Brass. chrome-plated (MSC)	18/30 LZ 1/250-MSC	978-06364
14	0.25	Brass. chrome-plated (MSC)	18/30 LZ 1/250-MSC	978-06365
10	0.5	Brass. chrome-plated (MSC)	18/30 LZ 1/500-MSC	978-06370
14	0.5	Brass. chrome-plated (MSC)	18/30 LZ 1/500-MSC	978-06371
10	0.75	Brass. chrome-plated (MSC)	18/30 LZ 1/750-MSC	978-06376
14	0.75	Brass. chrome-plated (MSC)	18/30 LZ 1/750-MSC	978-06377
10	1	Brass. chrome-plated (MSC)	18/30 LZ 1/1000-MSC	978-06382
14	1	Brass. chrome-plated (MSC)	18/30 LZ 1/1000-MSC	978-06383
10	1.5	Brass. chrome-plated (MSC)	18/30 LZ 1/1500-MSC	978-06388
14	1.5	Brass. chrome-plated (MSC)	18/30 LZ 1/1500-MSC	978-06389
10	2	Brass. chrome-plated (MSC)	18/30 LZ 1/2000-MSC	978-06394
14	2	Brass. chrome-plated (MSC)	18/30 LZ 1/2000-MSC	978-06395

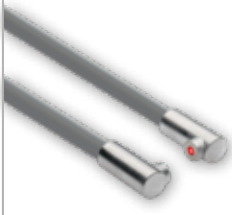
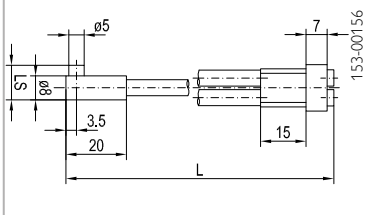
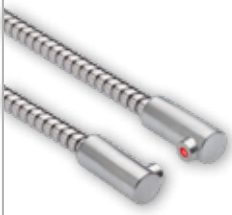
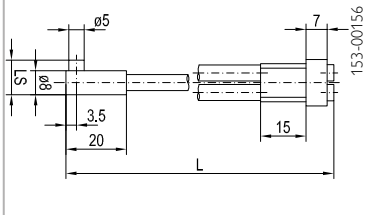

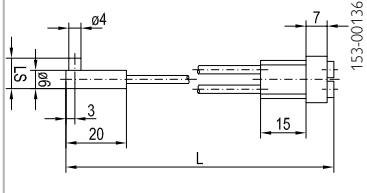
# Fibre-optic cables – standard

18/30 LZ 2/...-Si fibre-optic cable		Highlights									
		<ul style="list-style-type: none"> <li>• Through-beam photoelectric sensor</li> <li>• Silicone, metal or PVC sheath</li> <li>• Straight light exit</li> <li>• Robust design</li> <li>• -20 ... +80°C / +160 °C</li> <li>• Fixing via mounting block MB 8 (MSC/Si) (Article number 903-05141)</li> <li>• Fixing via mounting block MB 6 (PVC) (Article number 903-05139)</li> <li>• For FMS devices</li> </ul>									
18/30 LZ 2/...-MSC fibre-optic cable											
18/30 LZ 2/...-PVC fibre-optic cable											
Fibre arrangement	FMS 18 typ. scanning distance/range (mm)	FMS 30 typ. scanning distance/range (mm)	Core fibre Ø (mm) (T=Transmitter; R=Receiver) Material	Sheath material	Ambient temperature (rigid installation)	Bending radius (mm)	Cable length (m)	Collar bushing Ø (mm)	LS (mm)		
Straight	360	400	1 x 1.6 (T) / 1 x 1.6 (R) (Si/MSC) 1 x 1.5 (T) / 1 x 1.5 (R) (PVC) Glass	See Selection Table	-20 ... +160 °C (Si/MSC) -20 ... +80 °C (PVC)	20 = (Si/MSC) 15 = (PVC)	See Selection Table	8 = (Si/MSC) 6 = (PVC)	See Selection Table		

LS (mm)	Length (m)	Sheath material	Part number	Article number
10	0.25	Silicone (Si)	18/30 LZ 2/250-Si	978-06402
14	0.25	Silicone (Si)	18/30 LZ 2/250-Si	978-06403
10	0.5	Silicone (Si)	18/30 LZ 2/500-Si	978-06408
14	0.5	Silicone (Si)	18/30 LZ 2/500-Si	978-06409
10	0.75	Silicone (Si)	18/30 LZ 2/750-Si	978-06414
14	0.75	Silicone (Si)	18/30 LZ 2/750-Si	978-06415
10	1	Silicone (Si)	18/30 LZ 2/1000-Si	978-06420
14	1	Silicone (Si)	18/30 LZ 2/1000-Si	978-06421
10	1.5	Silicone (Si)	18/30 LZ 2/1500-Si	978-06426
14	1.5	Silicone (Si)	18/30 LZ 2/1500-Si	978-06427
10	2	Silicone (Si)	18/30 LZ 2/2000-Si	978-06432
14	2	Silicone (Si)	18/30 LZ 2/2000-Si	978-06433

LS (mm)	Length (m)	Sheath material	Part number	Article number
10	0.25	Brass, chrome-plated (MSC)	18/30 LZ 2/250-MSC	978-06400
14	0.25	Brass, chrome-plated (MSC)	18/30 LZ 2/250-MSC	978-06401
10	0.5	Brass, chrome-plated (MSC)	18/30 LZ 2/500-MSC	978-06406
14	0.5	Brass, chrome-plated (MSC)	18/30 LZ 2/500-MSC	978-06407
10	0.75	Brass, chrome-plated (MSC)	18/30 LZ 2/750-MSC	978-06412
14	0.75	Brass, chrome-plated (MSC)	18/30 LZ 2/750-MSC	978-06413
10	1	Brass, chrome-plated (MSC)	18/30 LZ 2/1000-MSC	978-06418
14	1	Brass, chrome-plated (MSC)	18/30 LZ 2/1000-MSC	978-06419
10	1.5	Brass, chrome-plated (MSC)	18/30 LZ 2/1500-MSC	978-06424
14	1.5	Brass, chrome-plated (MSC)	18/30 LZ 2/1500-MSC	978-06425
10	2	Brass, chrome-plated (MSC)	18/30 LZ 2/2000-MSC	978-06430
14	2	Brass, chrome-plated (MSC)	18/30 LZ 2/2000-MSC	978-06431
10	0.25	PVC	18/30 LZ 2/250-PVC	978-06398
14	0.25	PVC	18/30 LZ 2/250-PVC	978-06399
10	0.5	PVC	18/30 LZ 2/500-PVC	978-06404
14	0.5	PVC	18/30 LZ 2/500-PVC	978-06405
10	0.75	PVC	18/30 LZ 2/750-PVC	978-06410
14	0.75	PVC	18/30 LZ 2/750-PVC	978-06411
10	1	PVC	18/30 LZ 2/1000-PVC	978-06416
14	1	PVC	18/30 LZ 2/1000-PVC	978-06417
10	1.5	PVC	18/30 LZ 2/1500-PVC	978-06422
14	1.5	PVC	18/30 LZ 2/1500-PVC	978-06423
10	2	PVC	18/30 LZ 2/2000-PVC	978-06428
14	2	PVC	18/30 LZ 2/2000-PVC	978-06429

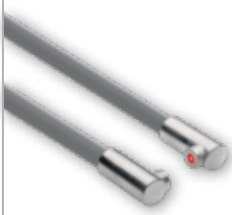
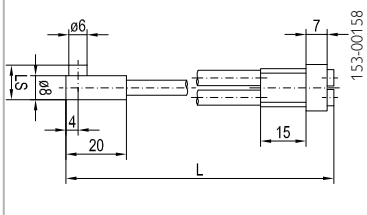
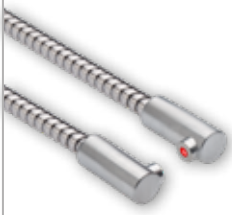
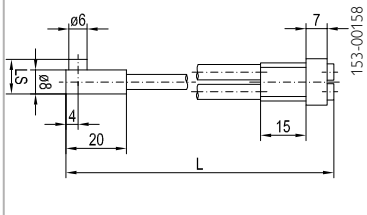
# Fibre-optic cables – standard

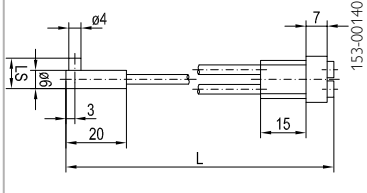

18/30 LZ 3/...-Si fibre-optic cable		Highlights									
		<ul style="list-style-type: none"> <li>• Through-beam photoelectric sensor</li> <li>• Silicone, metal or PVC sheath</li> <li>• Straight light exit</li> <li>• Robust design</li> <li>• -20 ... +80°C / +160 °C</li> <li>• Fixing via mounting block MB 8 (Si/MSC) (Article number 903-05141)</li> <li>• Fixing via mounting block MB 6 (PVC) (Article number 903-05139)</li> <li>• For FMS devices</li> </ul>									
18/30 LZ 3/...-MSC fibre-optic cable											
18/30 LZ 3/...-PVC fibre-optic cable											
Fibre arrangement	FMS 18 typ. scanning distance/range (mm)	FMS 30 typ. scanning distance/range (mm)	Core fibre Ø (mm) (T=Transmitter; R=Receiver) Material	Sheath material	Ambient temperature (rigid installation)	Bending radius (mm)	Cable length (m)	Collar bushing Ø (mm)	LS (mm)		
Straight	700	1000	1 x 2.0 (T) / 1 x 2.0 (R) Glass	See Selection Table	-20 ... +160 °C (Si/MSC) -20 ... +80 °C (PVC)	20	See Selection Table	8 = (Si/MSC) 6 = (PVC)	See Selection Table		

LS (mm)	Length (m)	Sheath material	Part number	Article number
10	0.25	Silicone (Si)	18/30 LZ 3/250-Si	978-06438
14	0.25	Silicone (Si)	18/30 LZ 3/250-Si	978-06439
10	0.5	Silicone (Si)	18/30 LZ 3/500-Si	978-06444
14	0.5	Silicone (Si)	18/30 LZ 3/500-Si	978-06445
10	0.75	Silicone (Si)	18/30 LZ 3/750-Si	978-06450
14	0.75	Silicone (Si)	18/30 LZ 3/750-Si	978-06451
10	1	Silicone (Si)	18/30 LZ 3/1000-Si	978-06456
14	1	Silicone (Si)	18/30 LZ 3/1000-Si	978-06457
10	1.5	Silicone (Si)	18/30 LZ 3/1500-Si	978-06462
14	1.5	Silicone (Si)	18/30 LZ 3/1500-Si	978-06463
10	2	Silicone (Si)	18/30 LZ 3/2000-Si	978-06468
14	2	Silicone (Si)	18/30 LZ 3/2000-Si	978-06469

LS (mm)	Length (m)	Sheath material	Part number	Article number
10	0.25	Brass, chrome-plated (MSC)	18/30 LZ 3/250-MSC	978-06436
14	0.25	Brass, chrome-plated (MSC)	18/30 LZ 3/250-MSC	978-06437
10	0.5	Brass, chrome-plated (MSC)	18/30 LZ 3/500-MSC	978-06442
14	0.5	Brass, chrome-plated (MSC)	18/30 LZ 3/500-MSC	978-06443
10	0.75	Brass, chrome-plated (MSC)	18/30 LZ 3/750-MSC	978-06448
14	0.75	Brass, chrome-plated (MSC)	18/30 LZ 3/750-MSC	978-06449
10	1	Brass, chrome-plated (MSC)	18/30 LZ 3/1000-MSC	978-06454
14	1	Brass, chrome-plated (MSC)	18/30 LZ 3/1000-MSC	978-06455
10	1.5	Brass, chrome-plated (MSC)	18/30 LZ 3/1500-MSC	978-06460
14	1.5	Brass, chrome-plated (MSC)	18/30 LZ 3/1500-MSC	978-06461
10	2	Brass, chrome-plated (MSC)	18/30 LZ 3/2000-MSC	978-06466
14	2	Brass, chrome-plated (MSC)	18/30 LZ 3/2000-MSC	978-06467
10	0.25	PVC	18/30 LZ 3/250-PVC	978-06434
14	0.25	PVC	18/30 LZ 3/250-PVC	978-06435
10	0.5	PVC	18/30 LZ 3/500-PVC	978-06440
14	0.5	PVC	18/30 LZ 3/500-PVC	978-06441
10	0.75	PVC	18/30 LZ 3/750-PVC	978-06446
14	0.75	PVC	18/30 LZ 3/750-PVC	978-06447
10	1	PVC	18/30 LZ 3/1000-PVC	978-06452
14	1	PVC	18/30 LZ 3/1000-PVC	978-06453
10	1.5	PVC	18/30 LZ 3/1500-PVC	978-06458
14	1.5	PVC	18/30 LZ 3/1500-PVC	978-06459
10	2	PVC	18/30 LZ 3/2000-PVC	978-06464
14	2	PVC	18/30 LZ 3/2000-PVC	978-06465

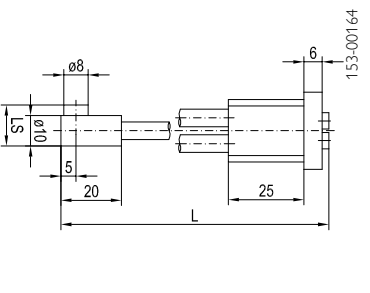

# Fibre-optic cables – standard

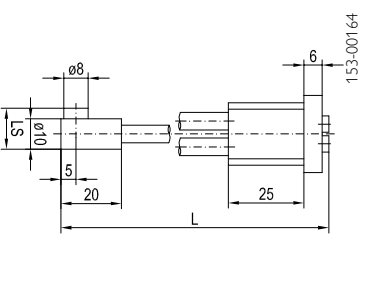

30 LZ 4/...-Si fibre-optic cable				Highlights						
				<ul style="list-style-type: none"> <li>• Through-beam photoelectric sensor</li> <li>• Silicone or metal sheath</li> <li>• Straight light exit</li> <li>• Long range</li> <li>• Robust design</li> <li>• -20 ... +160 °C</li> <li>• Fixing via mounting block MB 10 (Article number 903-05142)</li> <li>• For FMS-30 devices</li> </ul>						
30 LZ 4/...-MSC fibre-optic cable										
										
Fibre arrangement	FMS 18 typ. scanning distance/range (mm)	FMS 30 typ. scanning distance/range (mm)	Core fibre Ø (mm) (T=Transmitter; R=Receiver) Material	Sheath material	Ambient temperature (rigid installation)	Bending radius (mm)	Cable length (m)	Collar bushing Ø (mm)	LS (mm)	
Straight	–	3000	1 × 2.3 (T) / 1 × 2.3 (R) Glass	See Selection Table	-20 ... +160 °C	25	See Selection Table	10	See Selection Table	

LS (mm)	Length (m)	Sheath material	Part number	Article number
16	0.25	Silicone (Si)	30 LZ 4/250-Si	978-06472
20	0.25	Silicone (Si)	30 LZ 4/250-Si	978-06473
16	0.5	Silicone (Si)	30 LZ 4/500-Si	978-06476
20	0.5	Silicone (Si)	30 LZ 4/500-Si	978-06477
16	0.75	Silicone (Si)	30 LZ 4/750-Si	978-06481
20	0.75	Silicone (Si)	30 LZ 4/750-Si	978-06482
16	1	Silicone (Si)	30 LZ 4/1000-Si	978-06485
20	1	Silicone (Si)	30 LZ 4/1000-Si	978-06486
16	1.5	Silicone (Si)	30 LZ 4/1500-Si	978-06489
20	1.5	Silicone (Si)	30 LZ 4/1500-Si	978-06490
16	2	Silicone (Si)	30 LZ 4/2000-Si	978-06493
20	2	Silicone (Si)	30 LZ 4/2000-Si	978-06494
16	0.25	Brass. chrome-plated (MSC)	30 LZ 4/250-MSC	978-06470
20	0.25	Brass. chrome-plated (MSC)	30 LZ 4/250-MSC	978-06471
16	0.5	Brass. chrome-plated (MSC)	30 LZ 4/500-MSC	978-06474
20	0.5	Brass. chrome-plated (MSC)	30 LZ 4/500-MSC	978-06475
16	0.75	Brass. chrome-plated (MSC)	30 LZ 4/750-MSC	978-06478
20	0.75	Brass. chrome-plated (MSC)	30 LZ 4/750-MSC	978-06480
16	1	Brass. chrome-plated (MSC)	30 LZ 4/1000-MSC	978-06483
20	1	Brass. chrome-plated (MSC)	30 LZ 4/1000-MSC	978-06484
16	1.5	Brass. chrome-plated (MSC)	30 LZ 4/1500-MSC	978-06487
20	1.5	Brass. chrome-plated (MSC)	30 LZ 4/1500-MSC	978-06488
16	2	Brass. chrome-plated (MSC)	30 LZ 4/2000-MSC	978-06491
20	2	Brass. chrome-plated (MSC)	30 LZ 4/2000-MSC	978-06492

30 LZ 12/...-Si fibre-optic cable				Highlights						
				<ul style="list-style-type: none"> <li>• Through-beam photoelectric sensor</li> <li>• Silicone or metal sheath</li> <li>• Straight light exit</li> <li>• Extremely insensitive to contamination</li> <li>• Robust design</li> <li>• -20 ... +160 °C</li> <li>• Fixing via mounting block MB 10 (Article number 903-05142)</li> <li>• For FMS-30 devices</li> </ul>						
30 LZ 12/...-MSC fibre-optic cable										
Fibre arrangement Light exit	FMS 18 typ. scanning distance/range (mm)	FMS 30 typ. scanning distance/range (mm)	Core fibre Ø (mm) (T=Transmitter; R=Receiver) Material	Sheath material	Ambient temperature (rigid installation)	Bending radius (mm)	Cable length (m)	Collar bushing Ø (mm)	LS (mm)	
Straight	–	4800	1 x 3.5 (T) / 1 x 3.5 (R) Glass	See Selection Table	-20 ... +160 °C	25	See Selection Table	10	See Selection Table	

LS (mm)	Length (m)	Sheath material	Part number	Article number
16	0.25	Silicone (Si)	30 LZ 12/250-Si	978-06529
20	0.25	Silicone (Si)	30 LZ 12/250-Si	978-06530
16	0.5	Silicone (Si)	30 LZ 12/500-Si	978-06533
20	0.5	Silicone (Si)	30 LZ 12/500-Si	978-06534
16	0.75	Silicone (Si)	30 LZ 12/750-Si	978-06537
20	0.75	Silicone (Si)	30 LZ 12/750-Si	978-06538
16	1	Silicone (Si)	30 LZ 12/1000-Si	978-06541
20	1	Silicone (Si)	30 LZ 12/1000-Si	978-06542
16	1.5	Silicone (Si)	30 LZ 12/1500-Si	978-06545
20	1.5	Silicone (Si)	30 LZ 12/1500-Si	978-06546
16	2	Silicone (Si)	30 LZ 12/2000-Si	978-06549
20	2	Silicone (Si)	30 LZ 12/2000-Si	978-06550
<hr/>				
16	0.25	Brass. chrome-plated (MSC)	30 LZ 12/250-MSC	978-06527
20	0.25	Brass. chrome-plated (MSC)	30 LZ 12/250-MSC	978-06528
16	0.5	Brass. chrome-plated (MSC)	30 LZ 12/500-MSC	978-06531
20	0.5	Brass. chrome-plated (MSC)	30 LZ 12/500-MSC	978-06532
16	0.75	Brass. chrome-plated (MSC)	30 LZ 12/750-MSC	978-06535
20	0.75	Brass. chrome-plated (MSC)	30 LZ 12/750-MSC	978-06536
16	1	Brass. chrome-plated (MSC)	30 LZ 12/1000-MSC	978-06539
20	1	Brass. chrome-plated (MSC)	30 LZ 12/1000-MSC	978-06540
16	1.5	Brass. chrome-plated (MSC)	30 LZ 12/1500-MSC	978-06543
20	1.5	Brass. chrome-plated (MSC)	30 LZ 12/1500-MSC	978-06544
16	2	Brass. chrome-plated (MSC)	30 LZ 12/2000-MSC	978-06547
20	2	Brass. chrome-plated (MSC)	30 LZ 12/2000-MSC	978-06548

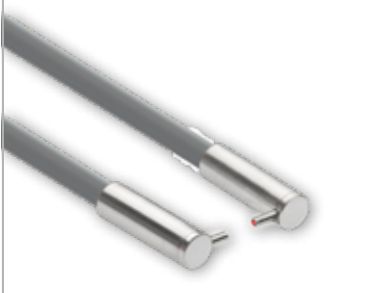
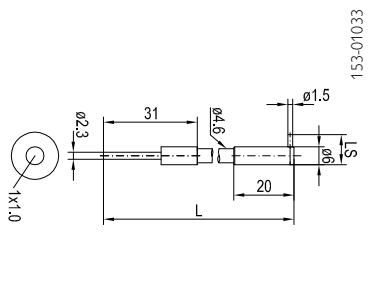
# Fibre-optic cables – standard

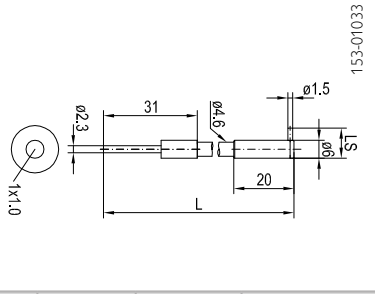
33 LZ 1/...-Si fibre-optic cable						Highlights					
						<ul style="list-style-type: none"> <li>• Through-beam photoelectric sensor</li> <li>• Silicone or metal sheath</li> <li>• Robust design</li> <li>• -20 ... +160 °C</li> <li>• Fixing via mounting block MB 6 (Article number 903-05139)</li> <li>• For FL 70/FL 20 devices</li> </ul>					
33 LZ 1/...-MSC fibre-optic cable											
											
Design	FL 70	FL 20	Fibre	Suitable for	Core fibre Ø (mm)	Sheath material	Ambient temperature	Fibre bending radius	Cable length	Collar bushing Ø	LS (mm)
Light exit	typ. scanning distance (mm) Standard / Fine / High	typ. scanning distance (mm) Default setting	arrangement	ancillary lens	(T = Transmitter; R = Receiver) Material		(rigid installation)	(mm)		(mm)	
Right-angle	270 / 165 / 550	140	See drawing	LVL F6-M4	1 x 1.0 (T) 1 x 1.0 (R) Glass	See Selection Table	-20 ... +160 °C	15	See selection table	6	10

Cable length	Sheath material	Part number	Article number
Up to 2 m	Silicone (Si)	33 LZ 1/...-Si	978-51581
Up to 2 m	Brass, chrome-plated (MSC)	33 LZ 1/...-MSC	978-51580

LLK2LZ fibre-optic cable						Highlights						
						<ul style="list-style-type: none"> <li>• Through-beam photoelectric sensor</li> <li>• Lateral light exit</li> <li>• Robust design</li> <li>• Fixing via mounting block MB 6 (Article number 903-05139)</li> <li>• Fibre length individually cuttable</li> <li>• For FL 70/FL 20 devices</li> </ul>						
Design	Light exit	FL 70 typ. scanning distance (mm) Standard / Fine / High	FL 20 typ. scanning distance (mm) Default setting	Fibre arrange- ment	Suitable for ancillary lens	Core fibre Ø (mm) (T = Transmitter; R = Receiver) Material	Sheath material	Ambient temperature (rigid installation)	Fibre bending radius (mm)	Cable length	Collar bushing Ø (mm)	LS (mm)
Straight		300 / 150 / 600	150	See drawing	–	16 x 0.25 (T) 16 x 0.25 (R) PMMA	Polyethylene (PE)	-40 ... +70 °C	15	2 m Cutable	8 Aluminium	10

Part number	Article number
LLK2LZ	950-50007

K2L-34 fibre-optic cable						Highlights						
						<ul style="list-style-type: none"> <li>• Through-beam photoelectric sensor</li> <li>• Lateral light exit</li> <li>• Bendable stainless steel tip</li> <li>• Particularly suitable for restricted spaces</li> <li>• Fibre length individually cuttable</li> <li>• For FL 70/FL 20 devices</li> </ul>						
Design	Light exit	FL 70 typ. scanning distance (mm) Standard / Fine / High	FL 20 typ. scanning distance (mm) Default setting	Fibre arrange- ment	Suitable for ancillary lens	Core fibre Ø (mm) (T = Transmitter; R = Receiver) Material	Sheath material	Ambient temperature (rigid installation)	Fibre bending radius (mm)	Cable length	Collar bushing	LS (mm)
Bendable mono / straight tip		100 / 35 / 150	150	–	–	1 x 1.0 (T) 1 x 1.0 (R) PMMA	Polyethylene (PE)	-40 ... +70 °C	15	2 m Cutable	Ø 1.5 mm Stainless steel	–

Part number	Article number
K2L-34	950-50002

# Fibre-optic cables – focused optics

The ideal solution for small-part detection

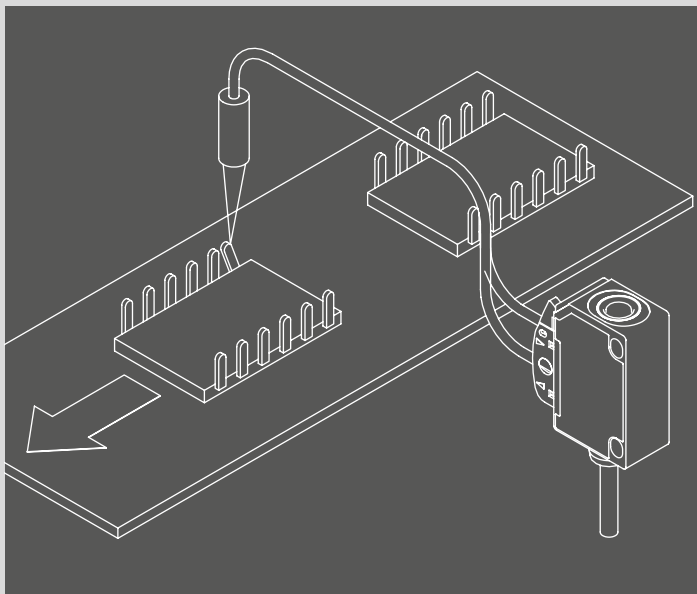

## Detection of IC pins

Even the smallest of objects, such as IC pins in electronics production, are reliably detected thanks to focused optics and a small light spot diameter.

## TYPICAL SENSOPART FIBRE-OPTIC CABLES

- Flexible plastic fibre-optic cables
- Coaxial fibres for precise object detection
- Adjustable scanning distances and light spot sizes

Coaxial fibre-optic cables are available with special ancillary optics for differing fixed or variable focus distances, especially for the detection of small objects. Light spot sizes of from 1.3 mm to 0.65 mm can be achieved with focusable coaxial fibre-optic cables. Special cable variants are also available for hole detection.



**Focused light spot:**

The three LLK1RDxV6 fixed focus variants with fixed focal distances (8/12/20 mm) offer maximum precision for small-part detection. The focus of the Varifocus LLK1RVV6 fibre-optic cable can be manually adjusted within a range of from 8 to 20 mm.

# Fibre-optic cables – with focused optics

Fibre-optic cable	Diffuse sensor (T) Photoelectric sensor (L)	Typical scanning distance/range	Light exit	Special features	For fibre-optic sensors
LLK1RD8V6-PE-1m	T	8 mm	Right-angle	<ul style="list-style-type: none"> <li>8 mm operating distance</li> <li>Very good small-part detection</li> <li>Small light spot</li> </ul>	FL 70
LLK1RD12V6-PE-1m	T	12 mm	Right-angle	<ul style="list-style-type: none"> <li>12 mm operating distance</li> <li>Very good small-part detection</li> <li>Small light spot</li> </ul>	FL 70
LLK1RD20V6-PE-1m	T	16 mm	Right-angle	<ul style="list-style-type: none"> <li>16 mm operating distance</li> <li>Very good small-part detection</li> <li>Small light spot</li> </ul>	FL 70
LLK1RVV6-PE-1m	T	8 ... 20 mm	Right-angle	<ul style="list-style-type: none"> <li>Very good small-part detection</li> <li>Scanning distance and light spot size, adjustable from 8 to 20 mm</li> </ul>	FL 70
LLK2LV6-PE-1m	L	> 2000 mm	Right-angle	<ul style="list-style-type: none"> <li>Very long range</li> </ul>	FL 70 / FL 20

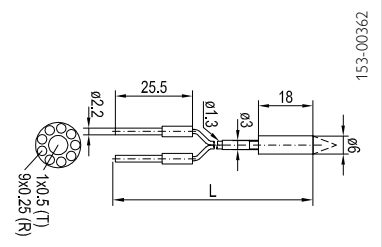
LLK1RD8V6 PE-1m fibre-optic cable					Highlights											
											<ul style="list-style-type: none"> <li>Photoelectric diffuse sensor</li> <li>Focused light spot at distance of 8.5 mm</li> <li>For small-part detection</li> <li>Fibre length individually cuttable</li> <li>For FL 70 devices</li> </ul>					
Design	FL 70	Fibre	Suitable	Core fibre	Sheath	Ambient	Fibre	Cable	Collar	LS						
Light exit	typ. scanning distance (mm) Standard / Fine / High	arrangement	for ancillary lens	Ø (mm) (T = Transmitter; R = Receiver) Material	material	temperature (rigid installation)	bending radius (mm)	length	bushing / ancillary optics	(mm)						
Coaxial, focused 8 mm, spot Ø 0.6 mm	8 / 8 / 8	See drawing	–	9 x 0.25 (R) 1 x 0.5 (T) PMMA	Polyethylene (PE)	-40 ... +60 °C	15	1 m Cuttable	Ø 6 mm Aluminium	–						

Part number	Article number
LLK1RD8V6 PE-1m	951-50009

LLK1RD12V6 PE-1m fibre-optic cable					Highlights						
					<ul style="list-style-type: none"> <li>• Photoelectric diffuse sensor</li> <li>• Focused light spot at distance of 12.5 mm</li> <li>• For small-part detection</li> <li>• Fibre length individually cuttable</li> <li>• For FL 70 devices</li> </ul>						
Design Light exit	FL 70 typ. scanning distance (mm) Standard / Fine / High	Fibre arrangement	Suitable for ancillary lens	Core fibre Ø (mm) (T = Transmitter; R = Receiver) Material	Sheath material	Ambient temperature (rigid installation)	Fibre bending radius (mm)	Cable length	Collar bushing / ancillary optics	LS (mm)	
Coaxial, focused 12 mm, spot Ø 0.7 mm	12 / 12 / 12	See drawing	–	9 × 0.25 (R) 1 × 0.5 (T) PMMA	Polyethylene (PE)	-40 ... +60 °C	15	1 m Cuttable	Ø 6 mm Aluminium	–	

Part number	Article number
LLK1RD12V6 PE-1m	951-50010

LLK1RD20V6 PE-1m fibre-optic cable					Highlights						
					<ul style="list-style-type: none"> <li>• Photoelectric diffuse sensor</li> <li>• Focused light spot at distance of 16 mm</li> <li>• For small-part detection</li> <li>• Fibre length individually cuttable</li> <li>• For FL 70 devices</li> </ul>						
Design Light exit	FL 70 typ. scanning distance (mm) Standard / Fine / High	Fibre arrangement	Suitable for ancillary lens	Core fibre Ø (mm) (T = Transmitter; R = Receiver) Material	Sheath material	Ambient temperature (rigid installation)	Fibre bending radius (mm)	Cable length	Collar bushing / ancillary optics	LS (mm)	
Coaxial, focused 16 mm, spot Ø 1.3 mm	16 / 16 / 16	See drawing	–	9 × 0.25 (R) 1 × 0.5 (T) PMMA	Polyethylene (PE)	-40 ... +60 °C	15	1 m Cuttable	Ø 6 mm Aluminium	–	

Part number	Article number
LLK1RD20V6 PE-1m	951-50011

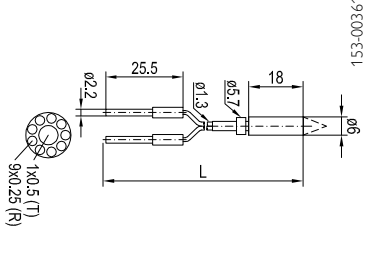

# Fibre-optic cables – with focused optics

LLK1RVV6-PE-1m fibre-optic cable					Highlights						
					<ul style="list-style-type: none"> <li>• Photoelectric diffuse sensor</li> <li>• Focal distance of light spot adjustable between 8 – 20 mm</li> <li>• For small-part detection</li> <li>• Fibre length individually cuttable</li> <li>• For FL 70 devices</li> </ul>						
Design	Light exit	FL 70 typ. scanning distance (mm) Standard / Fine / High	Fibre arrange- ment	Suitable for ancillary lens	Core fibre Ø (mm) (T = Transmitter; R = Receiver) Material	Sheath material	Ambient temperature (rigid installation)	Fibre bending radius (mm)	Cable length	Collar bushing / ancillary optics	LS (mm)
Coaxial, variable focus 8-20 mm, spot Ø 0.6-1.3 mm		8-20 / 8-20 / 8-20	See drawing	–	9 x 0.25 (T) 1 x 0.5 (R) PMMA	Polyethylene (PE)	-40 ... +60 °C	15	1 m Cuttable	Ø 6 mm Aluminium	–

Part number	Article number
LLK1RVV6-PE-1m	951-50008

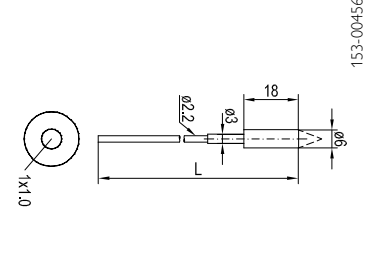
LLK2LV6-PE-1m fibre-optic cable					Highlights							
					<ul style="list-style-type: none"> <li>• Through-beam photoelectric sensor</li> <li>• Expanded range due to ancillary lens</li> <li>• Fibre length individually cuttable</li> <li>• For FL 70/FL 20 devices</li> </ul>							
Design	Light exit	FL 70 typ. scanning distance (mm) Standard / Fine / High	FL 20 typ. scanning distance (mm) Default setting	Fibre arrange- ment	Suitable for ancillary lens	Core fibre Ø (mm) (T = Transmitter; R = Receiver) Material	Sheath material	Ambient temperature (rigid installation)	Fibre bending radius (mm)	Cable length	Collar bushing / ancillary optics	LS (mm)
Right-angle, collimation optics		> 2000 / > 2000 / > 2000	1000	See drawing	–	1 x 1.0 (T) 1 x 1.0 (R) PMMA	Polyethylene (PE)	-40 ... +60 °C	25	1 m Cuttable	Ø 6 mm Aluminium	–

Part number	Article number
LLK2LV6-PE-1m	950-50006

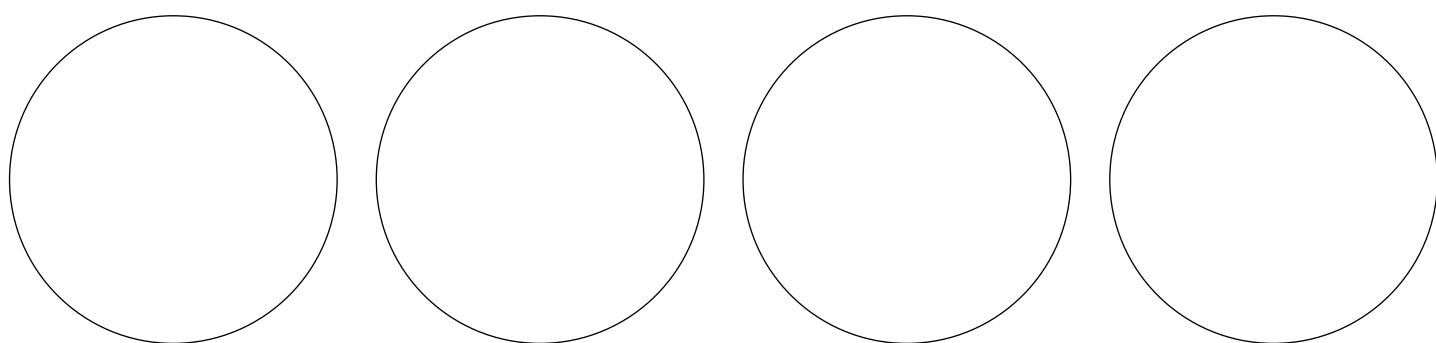

# Fibre-optic cables – light strips

For edge control and area detection

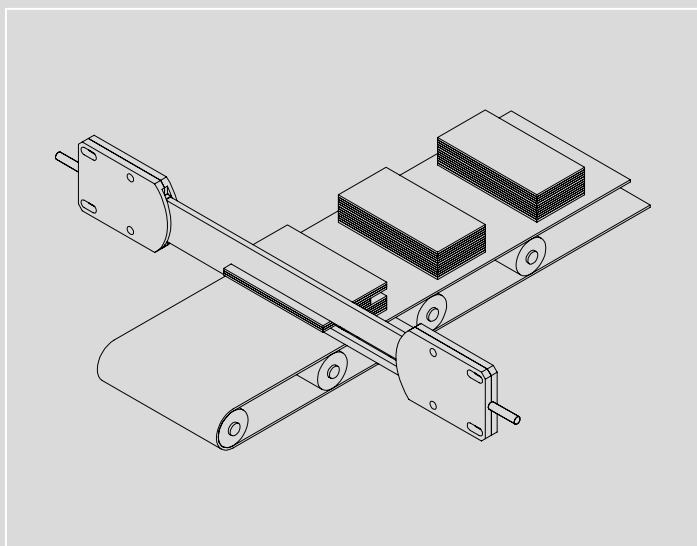

## Monitoring stack height

When an object enters the detection area of the LLK2SLR fibre-optic cable, the connected FL 70 RA sensor receives a weakened light signal. The transmitted analogue value is proportional to the light signal and thus allows monitoring of the stack height.

## TYPICAL SENSOPART FIBRE-OPTIC CABLES

- Long ranges
- Several light strip widths available
- Special designs for harsh operating conditions



## Cross-section converter





While the light exit of standard glass fibres is round, cross-section converters have a light exit that is designed as a rectangle or a thin line, for example.

A light strip can be of advantage for particular applications, e.g. for edge control during the production of foils, paper, sheet metals or textiles, or for measuring thickness and position. For such cases, fibre-optic cables are used with a special light exit sleeve – a so-called cross-section converter that generates a wide rectangular light strip. Sensopart offers light strips in a variety of designs and materials.

LLK2SLR fibre-optic cables combined with the FL 70 RA fibre-optic sensor are of particular importance. This system allows determination of the size of objects in the optical path.

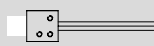
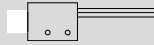
LLK2SLR fibre-optic cables spread a light strip in through-beam photoelectric sensor operation. When an object enters the optical path, the information is passed on to the FL 70 RA fibre-optic sensor which provides an absolute value via its analogue output. This allows, for example, the monitoring of stack heights, the sorting of small parts, the measurement of thicknesses and much more besides.

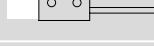
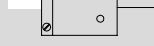
# Fibre-optic cables – light strips

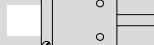
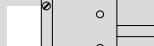
Fibre-optic cable		Diffuse sensor (T) Photoelectric sensor (L)	Typical range	Light exit	Special features	For fibre-optic sensors
LLK1QRR10x10-PE-2m		T	Up to 15 mm	Right-angle	<ul style="list-style-type: none"> <li>Small design for restricted spaces</li> <li>Precise switching behaviour on lateral approach</li> </ul>	FL 70 / FL 20
LLK2QRR19x25-PE-2m		T	Up to 15 mm	Right-angle	<ul style="list-style-type: none"> <li>Precise switching behaviour on lateral approach</li> </ul>	FL 70 / FL 20
LLK2SLR10-PE-2m		L	Up to 2000 mm	Right-angle	<ul style="list-style-type: none"> <li>Small-part detection to 0.5 mm</li> <li>Wide detection area</li> <li>Long range</li> </ul>	FL 70 / FL 20
K2Q-12		L	Up to 550 mm	Right-angle	<ul style="list-style-type: none"> <li>Small design for restricted spaces</li> </ul>	FL 70 / FL 20
30 QL 0,2x10/...-Si		L	Up to 500 mm	Right-angle	<ul style="list-style-type: none"> <li>10 mm light strip width</li> <li>Robust design</li> </ul>	FMS 18 / FMS 30 / FAV 30
30 QL 0,2x20/...-Si		L	Up to 500 mm	Right-angle	<ul style="list-style-type: none"> <li>20 mm light strip width</li> <li>Robust design</li> </ul>	FMS 18 / FMS 30 / FAV 30
30 QL 0,2x30/...-Si		L	Up to 500 mm	Right-angle	<ul style="list-style-type: none"> <li>30 mm light strip width</li> <li>Robust design</li> </ul>	FMS 18 / FMS 30 / FAV 30
30 QL 0,2x40/...-Si		L	Up to 500 mm	Right-angle	<ul style="list-style-type: none"> <li>40 mm light strip width</li> <li>Long range</li> <li>Robust design</li> </ul>	FMS 18 / FMS 30 / FAV 30

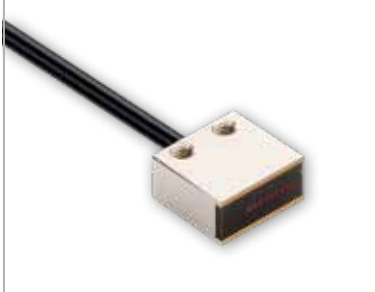
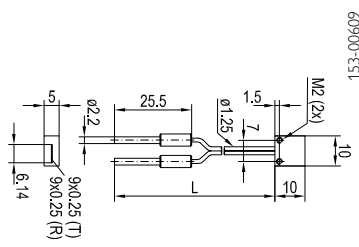
LLK1QRR10x10-PE-2m fibre-optic cable						Highlights					
											
<ul style="list-style-type: none"> <li>Photoelectric diffuse sensor</li> <li>For area monitoring or position detection</li> <li>Precise switching behaviour on lateral approach</li> <li>Elongated light exit (0.25 x 6.14 mm<sup>2</sup>)</li> <li>Fibre length individually cuttable</li> <li>For FL 70/FL 20 devices</li> </ul>											
Design	FL 70 typ. scanning distance (mm) Standard / Fine / High	FL 20 typ. scanning distance (mm) Default setting	Fibre arrangement	Suitable for ancillary lens	Core fibre Ø (mm) (T = Transmitter; R = Receiver) Material	Sheath material	Ambient temperature (rigid installation)	Fibre bending radius (mm)	Cable length	Collar bushing / head	LS (mm)
Cross-section converter line	1-15 / 1-15 / 1-15	1-15	See drawing	–	9 x 0.25 (T) 9 x 0.25 (R) PMMA	Polyethylene (PE)	-40 ... +70 °C	25	2 m Cuttable	10 x 10 x 5 mm M2 Brass, nickel-plated	–

Part number	Article number
LLK1QRR10x10-PE-2m	750-11003

LLK2QRR19x25-PE-2m fibre-optic cable						Highlights					
						<ul style="list-style-type: none"> <li>• Photoelectric diffuse sensor</li> <li>• For area monitoring or position detection</li> <li>• Precise switching behaviour on lateral approach</li> <li>• Elongated light exit (0.25 x 11 mm<sup>2</sup>)</li> <li>• Fibre length individually cuttable</li> <li>• For FL 70/FL 20 devices</li> </ul>					
Design Light exit	FL 70 typ. scanning distance (mm) Standard / Fine / High	FL 20 typ. scanning distance (mm) Default setting	Fibre arrangement	Suitable for ancillary lens	Core fibre Ø (mm) (T = Transmitter; R = Receiver) Material	Sheath material	Ambient temperature (rigid installation)	Fibre bending radius (mm)	Cable length	Collar bushing / head	LS (mm)
Cross-section converter line	1-15 / 1-15 / 1-15	1-15	See drawing	–	16 x 0.25 (T) 16 x 0.25 (R) PMMA	Polyethylene (PE)	-40 ... +70 °C	25	2 m Cutable	19 x 25 x 6 mm M3 Brass, nickel-plated	–

Part number	Article number
LLK2QRR19x25-PE-2m	750-11004

LLK2SLR10-PE-2m fibre-optic cable						Highlights					
						<ul style="list-style-type: none"> <li>• Through-beam photoelectric sensor</li> <li>• Wide detection range (15 mm)</li> <li>• Small-part detection to 0.5 mm</li> <li>• Flexible mounting possibilities</li> <li>• For measuring thickness and position</li> <li>• Long range</li> <li>• High-quality glass optics</li> <li>• Parallel beam guidance</li> <li>• Robust metal housing</li> <li>• For FL 70/FL 20 devices</li> </ul>					
Design Light exit	FL 70 typ. scanning distance (mm) Standard / Fine / High	FL 20 typ. scanning distance (mm) Default setting	Fibre arrangement	Suitable for ancillary lens	Core fibre Ø (mm) (T = Transmitter; R = Receiver) Material	Sheath material	Ambient temperature (rigid installation)	Fibre bending radius (mm)	Cable length	Collar bushing / head	LS (mm)
Right-angle	600-1500 / 0-600 / 1300-2000	1-15	–	–	1 x 0.25 PMMA Glass optics	Polyethylene (PE)	-20 ... +60 °C	25	2 m Cutable	See drawing	–

Part number	Article number
LLK2SLR10-PE-2m	952-50001

# Fibre-optic cables – light strips

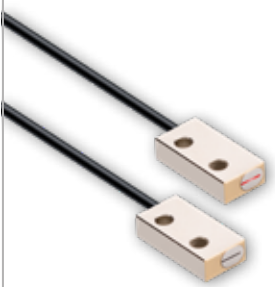
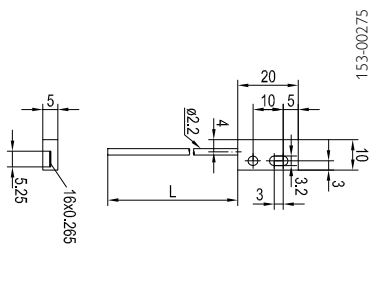
K2Q-12 fibre-optic cable						Highlights					
						<ul style="list-style-type: none"> <li>• Through-beam photoelectric sensor</li> <li>• Light strip for position detection or area monitoring</li> <li>• Fibre length individually cutable</li> <li>• For FL 70/FL 20 devices</li> </ul>					
Design Light exit	FL 70 typ. scanning distance (mm) Standard / Fine / High	FL 20 typ. scanning distance (mm) Default setting	Fibre arrangement	Suitable for ancillary lens	Core fibre Ø (mm) (T = Transmitter; R = Receiver) Material	Sheath material	Ambient temperature (rigid installation)	Fibre bending radius (mm)	Cable length	Collar bushing / head	LS (mm)
Cross-section converter	250 / 155 / 550	130	See drawing	–	16 x 0.265 (T) 16 x 0.265 (R) PMMA	Polyethylene (PE)	-40 ... +70 °C	15	2 m Cutable	20 x 10 mm Brass, nickel-plated	–

Part number	Article number
K2Q-12	952-50000

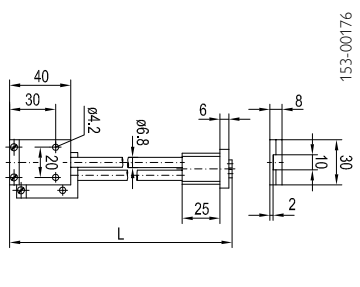
30 QL 0,2x10/...-Si fibre-optic cable					Highlights					
					<ul style="list-style-type: none"> <li>• Through-beam photoelectric sensor</li> <li>• Cross-section converter</li> <li>• 10 mm light exit</li> <li>• Robust design with silicone sheath</li> <li>• -20 ... +160 °C</li> <li>• For FMS/FAV 30 devices</li> </ul>					
Fibre arrangement Light exit	FAV 30 Distance: transmitter – receiver (mm)	Operating range (mm)	Core fibre Ø (mm) (T=Transmitter;R=Receiver) Material	Sheath material	Ambient temperature (rigid installation)	Bending radius (mm)	Cable length (m)	Collar bushing / head	LS (mm)	
Cross-section converter	50 - 80	6	0.2 x 10 (T) / 0.2 x 10 (R) Glass	Silicone (Si)	-20 ... +160 °C	25	See Selection Table	See drawing	–	

Length (m)	Part number	Article number
0.5	30 QL 0,2x10/500-Si	974-09621
1	30 QL 0,2x10/1000-Si	974-09617

30 QL 0,2x20/...-Si fibre-optic cable					Highlights					
					<ul style="list-style-type: none"> <li>• Through-beam photoelectric sensor</li> <li>• Cross-section converter</li> <li>• 20 mm light exit</li> <li>• Robust design with silicone sheath</li> <li>• -20 ... +160 °C</li> <li>• For FMS/FAV 30 devices</li> </ul>					
Fibre arrangement Light exit	FAV 30 Distance: transmitter – receiver (mm)	Operating range (mm)	Core fibre Ø (mm) (T=Transmitter; R=Receiver) Material	Sheath material	Ambient temperature (rigid installation)	Bending radius (mm)	Cable length (m)	Collar bushing / head	LS (mm)	
Cross-section converter	50 - 200	12	0,2 x 20 (T) / 0,2 x 20 (R) Glass	Silicone (Si)	-20 ... +160 °C	25	See Selection Table	See drawing	–	

Length (m)	Part number	Article number
0,5	30 QL 0,2x20/500-Si	974-09622
1	30 QL 0,2x20/1000-Si	974-09618

30 QL 0,2x30/...-Si fibre-optic cable					Highlights					
					<ul style="list-style-type: none"> <li>• Through-beam photoelectric sensor</li> <li>• Cross-section converter</li> <li>• 30 mm light exit</li> <li>• Robust design with silicone sheath</li> <li>• -20 ... +160 °C</li> <li>• For FMS/FAV 30 devices</li> </ul>					
Fibre arrangement Light exit	FAV 30 Distance: transmitter – receiver (mm)	Operating range (mm)	Core fibre Ø (mm) (T=Transmitter; R=Receiver) Material	Sheath material	Ambient temperature (rigid installation)	Bending radius (mm)	Cable length (m)	Collar bushing / head	LS (mm)	
Cross-section converter	100 - 300	18	0,2 x 30 (T) / 0,2 x 30 (R) Glass	Silicone (Si)	-20 ... +160 °C	25	See Selection Table	See drawing	–	

Length (m)	Part number	Article number
0,5	30 QL 0,2x30/500-Si	974-09623
1	30 QL 0,2x30/1000-Si	974-09619

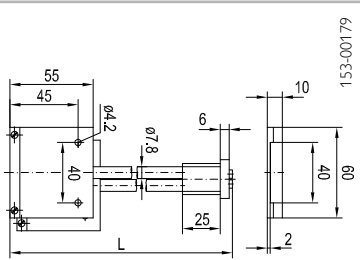

# Fibre-optic cables – light strips

30 QL 0,2x40/...-Si fibre-optic cable				Highlights					
				<ul style="list-style-type: none"> <li>• Through-beam photoelectric sensor</li> <li>• Cross-section converter</li> <li>• 40 mm light exit</li> <li>• Robust design with silicone sheath</li> <li>• -20 ... 160 °C</li> <li>• For FMS/FAV 30 devices</li> </ul>					
Fibre arrangement	FAV 30	Operating range (mm)	Core fibre Ø (mm)	Sheath material	Ambient temperature (rigid installation)	Bending radius (mm)	Cable length (m)	Collar bushing / head	LS (mm)
Light exit	Distance: transmitter – receiver (mm)		(T=Transmitter; R=Receiver) Material						
Cross-section converter	220 - 500	24	0.2 x 40 (T) / 0.2 x 40 (R) Glass	Silicone (Si)	-20 ... +160 °C	25	See Selection Table	See drawing	–

Length (m)	Part number	Article number
0.5	30 QL 0,2x40/500-Si	974-09624
1	30 QL 0,2x40/1000-Si	974-09620

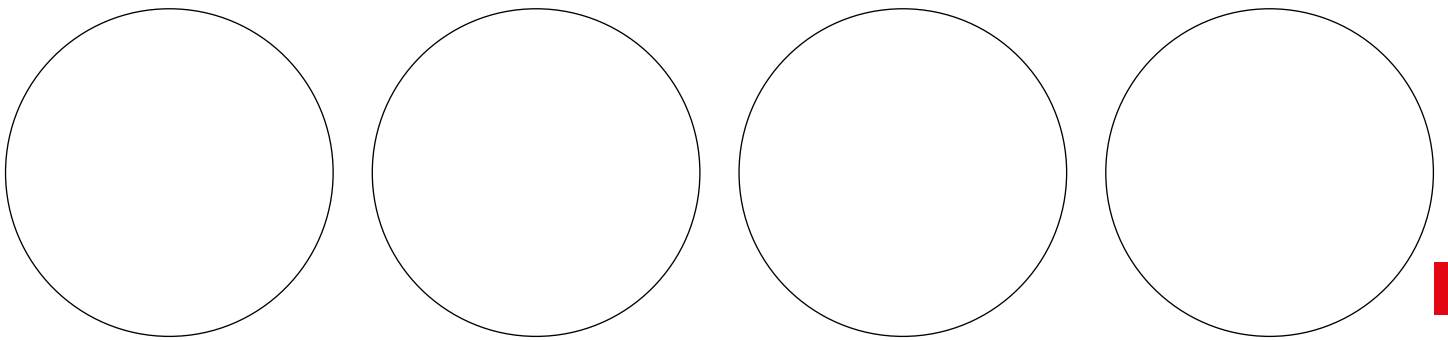

# Fibre-optic cables – special designs

Fibre-optic cables for special requirements

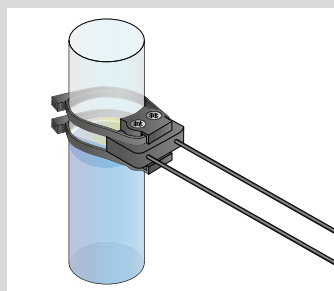

**Level measurement with fibre-optic cables:** This photoelectric diffuse sensor can be mounted on transparent vessels, pipes and tubes with diameters of 6 to 26 mm. Reliable detection of liquids and levels is guaranteed – even with non-transparent liquids.

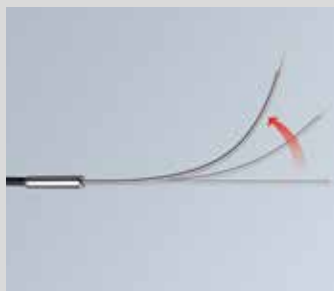

**Flexible scanning heads**  
The bundle of glass-fibres in a fibre-optic cable ends with a flexible scanning head in a small, thin, bendable stainless steel tube. This tube can be bent into the necessary shape for mounting in hard-to-reach locations.

## TYPICAL SENSOPART FIBRE-OPTIC CABLES

- Fine, flexible stainless steel tips for highly restricted and hard-to-reach installation locations
- V-scanners with small, flexible mounting heads for detecting small objects
- Prismatic scanners and V-scanners for monitoring liquids and filling levels
- Fork sensors in particularly small housings
- Compact installation dimensions
- Reliable detection

SensoPart offers a variety of special fibre-optic cable designs for particular applications and installation situations. Fork sensors, for example: in the fork design, the transmitter and receiver are precisely adjusted towards one another so that no alignment is necessary. Typical applications are the reliable detection of marks on continuous strips and small-part detection from a diameter of 0.2 mm.

Fibre-optic cables with very fine, flexible stainless steel tips are another highlight. The extraordinarily thin tube diameter allows access to extremely restricted spaces. The stainless steel tip can be individually reshaped with small bending radii and remains stable in this position. This ensures smooth process operation.

Particularly precise filling level monitoring is achieved by level sensors with glass tips. The sensor operates according to the principle of total reflection. The transmitted light is totally reflected in air in the prismatic tip and reaches the receiver without any appreciable loss. If the tip is now immersed in liquid, the refractive index changes and some of the light is refracted in the liquid. The light now arriving at the receiver is dampened and the sensor switches.

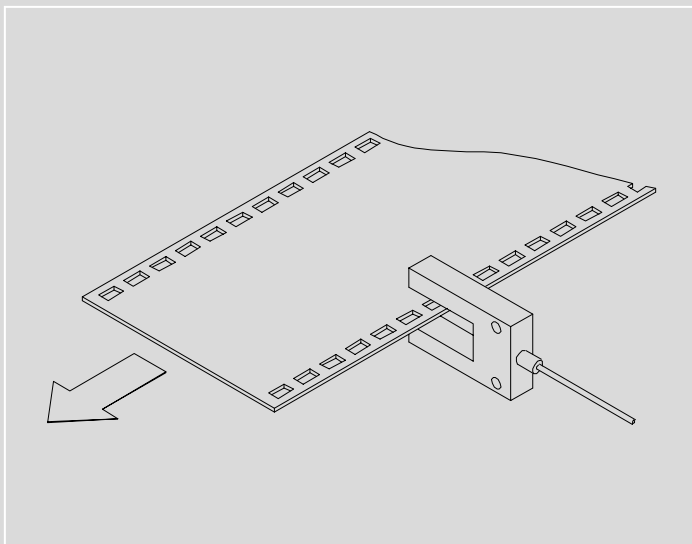

**Perforation detection with a fork sensor**



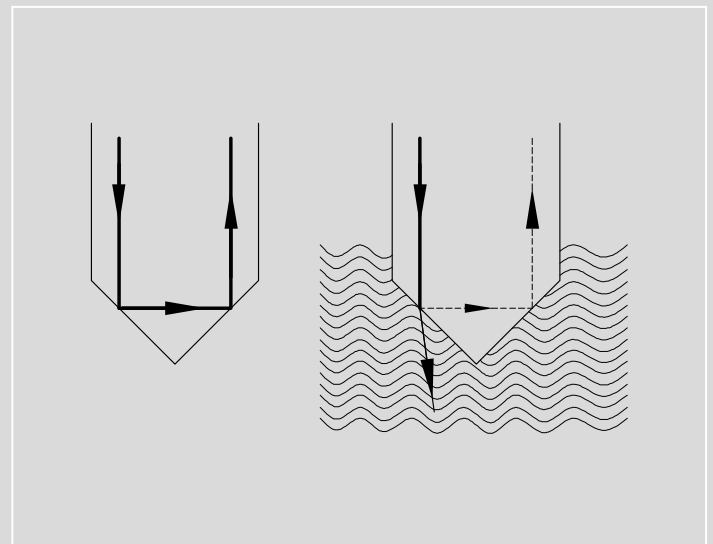





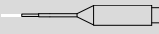
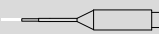
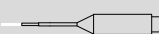
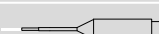

The fork sensor reliably detects the pattern of holes on the strip. Simple alignment and mounting, as well as its reliable detection principle, ensures trouble-free production processes.

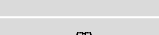

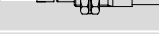
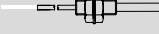
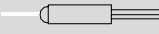
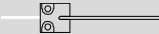
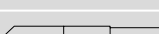
**Method of function of the prismatic scanner**

If the glass prism of the prismatic scanner is in air (left), total reflection results in almost all the light energy being reflected back to the receiver element of the fibre-optic sensor. If the refractive index of the surrounding liquid medium is large enough ( $n > 1.20$ ), most of the light energy is coupled on the interface of the prismatic tip. The fibre-optic sensor switches.

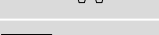
# Fibre-optic cables – special designs

Fibre-optic cable	Diffuse sensor (T) Photoelectric sensor (L)	Typical range	Light exit	Special features	For fibre-optic sensors	
18/30 R 0,5/xxxx-Si		T	Up to 3 mm	Right-angle	<ul style="list-style-type: none"> <li>Very fine bendable stainless steel tip</li> <li>For restricted spaces</li> </ul>	FMS 18 / FMS 30
18/30 R 1,5/xxxx-Si		T	Up to 15 mm	Right-angle	<ul style="list-style-type: none"> <li>Bendable stainless steel tip</li> <li>For restricted spaces</li> </ul>	FMS 18 / FMS 30
18/30 L 0,5/xxxx-Si		L	Up to 20 mm	Right-angle	<ul style="list-style-type: none"> <li>Very fine bendable stainless steel tip</li> <li>For restricted spaces</li> </ul>	FMS 18 / FMS 30
18/30 L 1,5/xxxx-Si		L	Up to 100 mm	Right-angle	<ul style="list-style-type: none"> <li>Bendable stainless steel tip</li> <li>For restricted spaces</li> </ul>	FMS 18 / FMS 30
K1R-103		T	Up to 105 mm	Right-angle	<ul style="list-style-type: none"> <li>Very fine bendable stainless steel tip</li> <li>For restricted spaces</li> </ul>	FL 70
K2R-100		T	Up to 290 mm	Right-angle	<ul style="list-style-type: none"> <li>Bendable stainless steel tip</li> <li>For restricted spaces</li> </ul>	FL 70 / FL 20
K2L-203		L	Up to 190 mm	Right-angle	<ul style="list-style-type: none"> <li>Very fine bendable stainless steel tip</li> <li>For restricted spaces</li> </ul>	FL 70 / FL 20
K2L-204		L	Up to 720 mm	Right-angle	<ul style="list-style-type: none"> <li>Bendable stainless steel tip</li> <li>For restricted spaces</li> </ul>	FL 70 / FL 20
K1R-104		T	Up to 205 mm	Right-angle	<ul style="list-style-type: none"> <li>Small-part and hole detection</li> </ul>	FL 70
LLK1L10x10-PE-2m		L	Up to 220 mm	Right-angle	<ul style="list-style-type: none"> <li>Particularly flat and flexible mounting head</li> <li>Fibre length individually cutable</li> </ul>	FL 70 / FL 20
18/30 RP 2/xxxx-Si		T	–	–	<ul style="list-style-type: none"> <li>Prismatic scanner for level detection</li> <li>Stainless steel head with glass prism</li> </ul>	FMS 18 / FMS 30
LLK2PR2-PE-2m		T	–	–	<ul style="list-style-type: none"> <li>Prismatic scanner for level detection</li> <li>Stainless steel head with glass prism</li> </ul>	FL 70 / FL 20
LLK1VRR22x15-PE-2m		T	–	V-scanner	<ul style="list-style-type: none"> <li>V-scanner for liquid or level detection</li> <li>Small housing</li> </ul>	FL 70 / FL 20
18/30 R 12/xxxx-N-02		T	Up to 800 mm	Right-angle	<ul style="list-style-type: none"> <li>Long range</li> <li>Immune to contamination</li> <li>Up to 250 °C</li> </ul>	FMS 18 / FMS 30
LLK1VRF5-PE-2m		T	4 mm	V-scanner	<ul style="list-style-type: none"> <li>V-scanner with lateral light exit</li> <li>Small housing</li> </ul>	FL 70 / FL 20
LLK1VRF17x18-PE-2m		T	7 mm	V-scanner	<ul style="list-style-type: none"> <li>V-scanner with lateral light exit</li> <li>Small housing</li> </ul>	FL 70
LLK1GL5-PE-2m		L	5 mm	Fork sensor	<ul style="list-style-type: none"> <li>Very compact housing</li> </ul>	FL 70 / FL 20
LLK1GL10-PE-2m		L	10 mm	Fork sensor	<ul style="list-style-type: none"> <li>Very compact housing</li> </ul>	FL 70 / FL 20

18/30 R 0,5/...-Si fibre-optic cable					Highlights				
					<ul style="list-style-type: none"> <li>• Photoelectric diffuse sensor</li> <li>• Very fine bendable stainless steel tip</li> <li>• Small right-angle light exit</li> <li>• Robust design with silicone sheath</li> <li>• -20 ... 160 °C</li> <li>• Fixing via mounting block MB 6 (Article number 903-05139)</li> <li>• For FMS devices</li> </ul>				
Fibre arrangement Light exit	FMS 18 typ. scanning distance/ range (mm)	FMS 30 typ. scanning distance/ range (mm)	Core fibre Ø (mm) material	Sheath material	Ambient temperature (rigid installation)	Bending radius (mm)	Cable length (m)	Collar bushing Ø (mm)	LS (mm)
Right-angle	1	3	1 x 0.4 Glass	Silicone (Si)	-20 ... 160 °C	15 (Si sheath) 5 (tip)	See Selection Table	6	-

Length (m)	Part number	Article number
0.25	18/30 R 0,5/250-Si	979-08069
0.5	18/30 R 0,5/500-Si	979-08097
1	18/30 R 0,5/750-Si	979-08070
2	18/30 R 0,5/1000-Si	979-08098

18/30 R 1,5/...-Si fibre-optic cable					Highlights				
					<ul style="list-style-type: none"> <li>• Photoelectric diffuse sensor</li> <li>• Bendable stainless steel tip</li> <li>• Small right-angle light exit</li> <li>• Robust design with silicone sheath</li> <li>• -20 ... +160 °C</li> <li>• Fixing via mounting block MB 6 (Article number 903-05139)</li> <li>• For FMS devices</li> </ul>				
Fibre arrangement Light exit	FMS 18 typ. scanning distance/ range (mm)	FMS 30 typ. scanning distance/ range (mm)	Core fibre Ø (mm) material	Sheath material	Ambient temperature (rigid installation)	Bending radius (mm)	Cable length (m)	Collar bushing Ø (mm)	LS (mm)
Right-angle	5	15	1 x 0.8 Glass	Silicone (Si)	-20 ... 160 °C	15 (Si sheath) 5 (tip)	See Selection Table	6	-

Length (m)	Part number	Article number
0.25	18/30 R 1,5/250-Si	979-08085
0.5	18/30 R 1,5/500-Si	979-08086
0.75	18/30 R 1,5/750-Si	979-08409
1	18/30 R 1,5/1000-Si	979-08087
1.5	18/30 R 1,5/1500-Si	979-08410
2	18/30 R 1,5/2000-Si	979-08088



K1R-103 fibre-optic cable					Highlights						
					<ul style="list-style-type: none"> <li>• Photoelectric diffuse sensor</li> <li>• Very fine bendable stainless steel tip</li> <li>• Particularly suitable for restricted spaces</li> <li>• Fibre length individually cuttable</li> <li>• For FL 70 devices</li> </ul>						
Design Light exit	FL 70 typ. scanning distance (mm) Standard / Fine / High	Fibre arrangement	Suitable for ancillary lens	Core fibre Ø (mm) (T = Transmitter; R = Receiver) Material	Sheath material	Ambient temperature (rigid installation)	Fibre bending radius (mm)	Cable length	Collar bushing	LS (mm)	
Mono / right-angle Bendable tip	60 / 20 / 105	See drawing	–	2 x 0.5 (T/R) PMMA	Polyethylene (PE)	-40 ... +70 °C	25	2 m Cutable	M3 Stainless steel	–	

Part number	Article number
K1R-103	720-50769

K2R-100 fibre-optic cable					Highlights						
					<ul style="list-style-type: none"> <li>• Photoelectric diffuse sensor</li> <li>• Bendable stainless steel tip</li> <li>• Particularly suitable for restricted spaces</li> <li>• Robust design</li> <li>• Fibre length individually cuttable</li> <li>• For FL 70/FL 20 devices</li> </ul>						
Design Light exit	FL 70 typ. scanning distance (mm) Standard / Fine / High	FL 20 typ. scanning distance (mm) Default setting	Fibre arrangement	Suitable for ancillary lens	Core fibre Ø (mm) (T = Transmitter; R = Receiver) Material	Sheath material	Ambient temperature (rigid installation)	Fibre bending radius (mm)	Cable length	Collar bushing	LS (mm)
Mono / right-angle	140 / 70 / 290	70	See drawing	–	2 x 1.0 (T/R) PMMA	Polyethylene (PE)	-40 ... +70 °C	25	2 m Cutable	M6x0.75 Stainless steel	–

Part number	Article number
K2R-100	720-50770

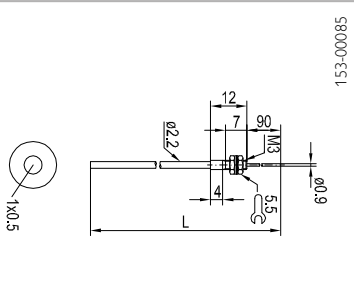

# Fibre-optic cables – special designs

K2L-203 fibre-optic cable						Highlights					
						<ul style="list-style-type: none"> <li>• Through-beam photoelectric sensor</li> <li>• Very fine bendable stainless steel tip</li> <li>• Particularly suitable for restricted spaces</li> <li>• Fibre length individually cuttable</li> <li>• For FL 70/FL 20 devices</li> </ul>					
Design	FL 70	FL 20	Fibre	Suitable	Core fibre	Sheath	Ambient	Fibre	Cable	Collar	LS
Light exit	typ. scanning distance (mm)	typ. scanning distance (mm)	arrangement	for ancillary lens	Ø (mm)	material	temperature (rigid installation)	bending radius (mm)	length	bushing	(mm)
	Standard / Fine / High	Default setting			(T = Transmitter; R = Receiver)						
Mono / right-angle	120 / 60 / 190	–	See drawing	–	1 x 0.5 (T) 1 x 0.5 (R) PMMA	Polyethylene (PE)	-40 ... +70 °C	15	2 m Cuttable	M3 Stainless steel	–

Part number	Article number
K2L-203	721-50773

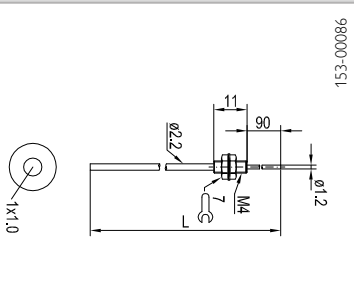
K2L-204 fibre-optic cable						Highlights					
						<ul style="list-style-type: none"> <li>• Through-beam photoelectric sensor</li> <li>• Very fine bendable stainless steel tip</li> <li>• Particularly suitable for restricted spaces</li> <li>• Fibre length individually cuttable</li> <li>• For FL 70/FL 20 devices</li> </ul>					
Design	FL 70	FL 20	Fibre	Suitable	Core fibre	Sheath	Ambient	Fibre	Cable	Collar	LS
Light exit	typ. scanning distance (mm)	typ. scanning distance (mm)	arrangement	for ancillary lens	Ø (mm)	material	temperature (rigid installation)	bending radius (mm)	length	bushing	(mm)
	Standard / Fine / High	Default setting			(T = Transmitter; R = Receiver)						
Mono / right-angle	350 / 195 / 720	180	See drawing	–	1 x 1.0 (T) 1 x 1.0 (R) PMMA	Polyethylene (PE)	-40 ... +70 °C	25	2 m Cuttable	M4 Stainless steel	–

Part number	Article number
K2L-204	721-50774

K1R-104 fibre-optic cable					Highlights						
					<ul style="list-style-type: none"> <li>• Photoelectric diffuse sensor</li> <li>• For detecting small parts and holes</li> <li>• Spherical optics for cylindrical light beam</li> <li>• Precise switching behaviour on lateral approach</li> <li>• Fibre length individually cuttable</li> <li>• For FL 70 devices</li> </ul>						
Design Light exit	FL 70 typ. scanning distance (mm) Standard / Fine / High	Fibre arrangement	Suitable for ancillary lens	Core fibre Ø (mm) (T = Transmitter; R = Receiver) Material	Sheath material	Ambient temperature (rigid installation)	Fibre bending radius (mm)	Cable length	Collar bushing	LS (mm)	
Spherical optics	80 / 45 / 205	See drawing	–	2 x 0.5 (T/R) PMMA	Polyethylene (PE)	-40 ... +70 °C	15	2 m Cutable	Ø 4 mm Stainless steel	–	

Part number	Article number
K1R-104	841-21006

LLK1L10x10-PE-2m fibre-optic cable					Highlights						
					<ul style="list-style-type: none"> <li>• Through-beam photoelectric sensor</li> <li>• Very small bending radius</li> <li>• Particularly flat and flexible mounting head</li> <li>• Fibre length individually cuttable</li> <li>• For FL 70/FL 20 devices</li> </ul>						
Design Light exit	FL 70 typ. scanning distance (mm) Standard / Fine / High	FL 20 typ. scanning distance (mm) Default setting	Fibre arrangement	Suitable for ancillary lens	Core fibre Ø (mm) (T = Transmitter; R = Receiver) Material	Sheath material	Ambient temperature (rigid installation)	Fibre bending radius (mm)	Cable length	Collar bushing	LS (mm)
Flat measurement head	120 / 50 / 220	–	See drawing	–	1 x 0.5 (T) 1 x 0.5 (R) PMMA	Polyethylene (PE)	-40 ... +70 °C	1	2 m Cutable	10 x 10 mm <sup>2</sup> M2 Brass, nickel-plated	–

Part number	Article number
LLK1L10x10-PE-2m	750-11010

# Fibre-optic cables – special designs

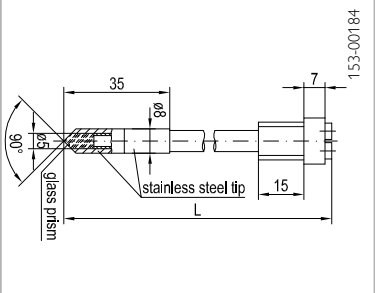
18/30 RP 2 /-Si fibre-optic cable				Highlights						
				<ul style="list-style-type: none"> <li>• Prismatic scanner for liquid and level detection</li> <li>• Straight light exit</li> <li>• Robust design with silicone sheath</li> <li>• -20 ... +120 °C</li> <li>• Fixing via mounting block MB 8 (Article number 903-05141)</li> <li>• For FMS devices</li> </ul>						
Fibre arrangement	FMS 18 typ. scanning distance/range (mm)	FMS 30 typ. scanning distance/range (mm)	Core fibre Ø (mm) material	Sheath material	Ambient temperature (rigid installation)	Bending radius (mm)	Cable length (m)	Collar bushing Ø (mm)	LS (mm)	
Right-angle	–	–	2 x 1.6 Glass	Silicone (Si)	-25 ... +120 °C	20	See Selection Table	8 Stainless steel	See Selection Table	

Length (m)	Part number	Article number
0.25	18/30 RP 2/250-Si	975-06584
0.5	18/30 RP 2/500-Si	975-06585
1	18/30 RP 2/1000-Si	975-06586
2	18/30 RP 2/2000-Si	975-06587

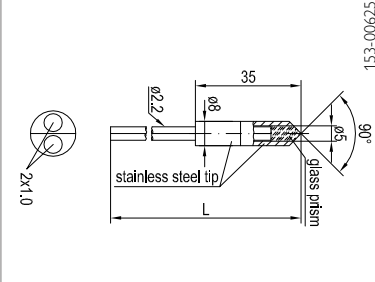
LLK2PR2-PE-2m fibre-optic cable				Highlights						
				<ul style="list-style-type: none"> <li>• Prismatic scanner for liquid and level detection</li> <li>• Fibre length individually cuttable</li> <li>• For FL 70 devices</li> </ul>						
Design	FL 70 typ. scanning distance (mm) Standard / Fine / High	Fibre arrangement	Suitable for ancillary lens	Core fibre Ø (mm) (T = Transmitter; R = Receiver) Material	Sheath material	Ambient temperature (rigid installation)	Fibre bending radius (mm)	Cable length	Collar bushing	LS (mm)
Prismatic scanner	–	See drawing	–	2 x 1.0 (T/R) PMMA	Polyethylene (PE)	-40 ... +70 °C	25	2 m Cutable	Ø 8 mm Stainless steel	–

Part number	Article number
LLK2PR2-PE-2m	951-50013

LLK1VRR22x15-PE-2m fibre-optic cable						Highlights						
						<ul style="list-style-type: none"> <li>• V-scanner for liquid and level detection in transparent vessels or tubes</li> <li>• Small housing</li> <li>• Fibre length individually cuttable</li> <li>• For FL 70/FL 20 devices</li> </ul>						
Design	Light exit	FL 70 typ. scanning distance (mm) Standard / Fine / High	FL 20 typ. scanning distance (mm) Default setting	Fibre arrange- ment	Suitable for ancillary lens	Core fibre Ø (mm) (T = Transmitter; R = Receiver) Material	Sheath material	Ambient temperature (rigid installation)	Fibre bending radius (mm)	Cable length	Collar bushing	LS (mm)
V-scanner		Ø 6-26 / Ø 6-26 / Ø 6-26	Ø 6-26	–	–	2 x 0.5 (T/R) PMMA	Polyethylene (PE)	-40 ... +70 °C	15	2 m Cuttable	15.5 x 22 x 11 mm <sup>3</sup> Polycarbonate (PC)	–

Part number	Article number
LLK1VRR22x15-PE-2m	750-11006

30 R 12/...-N-02 fibre-optic cable					Highlights					
					<ul style="list-style-type: none"> <li>• Photoelectric diffuse sensor</li> <li>• Right-angle light exit</li> <li>• High scanning distance/range</li> <li>• Extremely robust design with stainless steel sheath</li> <li>• -25 ... +250 °C</li> <li>• For FMS-30 devices</li> </ul>					
Fibre arrangement	Light exit	FMS 18 typ. scanning distance/ range (mm)	FMS 30 typ. scanning distance/ range (mm)	Core fibre Ø (mm) material	Sheath material	Ambient temperature (rigid installation)	Bending radius (mm)	Cable length (m)	Collar bushing Ø (mm)	LS (mm)
Right-angle		–	800	2 x 3.5 Glass	Stainless steel, helical sleeve	-25 ... +250 °C	45 (once) 100 (more than once)	See Selection Table	M18 x 1	–

Length (m)	Part number	Article number
0.5	30 R 12/500-N-02	979-05281
0.75	30 R 12/750-N-02	979-50546
1	30 R 12/1000-N-02	979-05280
1.5	30 R 12/1500-N-02	979-05279
2	30 R 12/2000-N-02	979-05278

# Fibre-optic cables – special designs

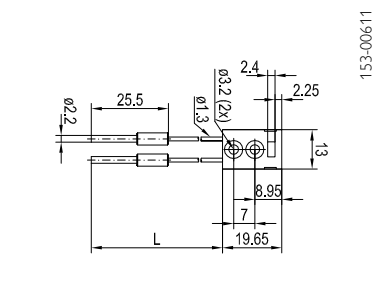
LLK1VRF5-PE-2m fibre-optic cable						Highlights					
						<ul style="list-style-type: none"> <li>V-scanner with lateral light exit</li> <li>Small housing</li> <li>Precise switching behaviour within operating range</li> <li>Fibre length individually cuttable</li> <li>For FL 70/FL 20 devices</li> </ul>					
Design	FL 70	FL 20	Fibre	Suitable	Core fibre	Sheath	Ambient	Fibre	Cable	Collar	LS
Light exit	typ. scanning distance (mm)	typ. scanning distance (mm)	arrangement	for ancillary lens	Ø (mm)	material	temperature (rigid installation)	bending radius (mm)	length	bushing	(mm)
	Standard / Fine / High	Default setting			(T = Transmitter; R = Receiver)						
V-scanner	4 / 4 / 4	4	–	–	2 x 1.0 (T/R)	Polyethylene (PE)	-40 ... +70 °C	25	2 m	19,6 x 13 x 5 mm <sup>3</sup>	–
Transp. Media					PMMA				Cutable	M3	
Straight										ABS plastic	

Part number	Article number
LLK1VRF5-PE-2m	750-11005

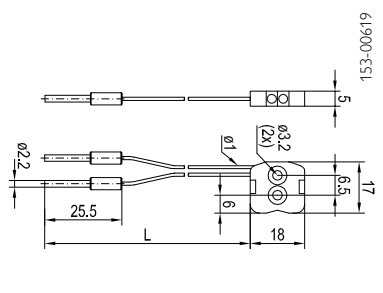
LLK1VRF17x18-PE-2m fibre-optic cable						Highlights					
						<ul style="list-style-type: none"> <li>V-scanner with lateral light exit</li> <li>Small housing</li> <li>Precise switching behaviour within operating range</li> <li>Fibre length individually cuttable</li> <li>For FL 70 devices</li> </ul>					
Design	FL 70	Fibre	Suitable	Core fibre	Sheath	Ambient	Fibre	Cable	Collar	LS	
Light exit	typ. scanning distance (mm)	arrangement	for ancillary lens	Ø (mm)	material	temperature (rigid installation)	bending radius (mm)	length	bushing	(mm)	
	Standard / Fine / High			(T = Transmitter; R = Receiver)							
V-scanner	7 / 7 / 7	–	–	2 x 0.5 (T/R)	Polyethylene (PE)	-40 ... +70 °C	15	2 m	17 x 18 x 5 mm <sup>3</sup>	–	
				PMMA				Cutable	M3		
									Polycarbonate (PC)		

Part number	Article number
LLK1VRF17x18-PE-2m	750-11009

LLK1GL5-PE-2m fibre-optic cable						Highlights					
						<ul style="list-style-type: none"> <li>• Fork sensor with very compact housing</li> <li>• Fibre length individually cutable</li> <li>• For FL 70/FL 20 devices</li> </ul>					
Design Light exit	FL 70 typ. scanning distance (mm) Standard / Fine / High	FL 20 typ. scanning distance (mm) Default setting	Fibre arrangement	Suitable for ancillary lens	Core fibre Ø (mm) (T = Transmitter; R = Receiver) Material	Sheath material	Ambient temperature (rigid installation)	Fibre bending radius (mm)	Cable length	Collar bushing	LS (mm)
Fork sensor 5 mm	5 / 5 / 5	5	–	–	1 × 0.25 (T) 1 × 0.25 (R) PMMA	Polyethylene (PE)	-40 ... +70 °C	10	2 m Cutable	31,7×20×7mm <sup>3</sup> M3 ABS plastic	–

Part number	Article number
LLK1GL5-PE-2m	750-11008

LLK1GL10-PE-2m fibre-optic cable						Highlights					
						<ul style="list-style-type: none"> <li>• Fork sensor with very compact housing</li> <li>• Fibre length individually cutable</li> <li>• For FL 70/FL 20 devices</li> </ul>					
Design Light exit	FL 70 typ. scanning distance (mm) Standard / Fine / High	FL 20 typ. scanning distance (mm) Default setting	Fibre arrangement	Suitable for ancillary lens	Core fibre Ø (mm) (T = Transmitter; R = Receiver) Material	Sheath material	Ambient temperature (rigid installation)	Fibre bending radius (mm)	Cable length	Collar bushing	LS (mm)
Fork sensor 10 mm	10 / 10 / 10	10	–	–	1 × 0.25 (T) / 1 × 0.25 (R) PMMA	Polyethylene (PE)	-40 ... +70 °C	10	2 m Cutable	40,7×15×7mm <sup>3</sup> M3 ABS plastic	–

Part number	Article number
LLK1GL10-PE-2m	750-11007

# Fibre-optic cables – accessories

Everything needed for using fibre-optic cable systems



From products “by the metre” to ancillary lenses – SensoPart offers all the accessories necessary for the use of fibre-optic sensors. The comprehensive range also includes a special combination tool with which the sensitive fibre-optic cables can be shortened and bent with almost no performance loss.

## TYPICAL SENSOPART FIBRE-OPTIC CABLES

- Ancillary lenses for expanding the range of standard fibre-optic cables
- Deflection head for restricted spaces
- Connection adapter for all conventional fibre-optic sensors
- Precise shortening and bending of fibre-optic cables with almost no performance loss

Fibre-optic cables – Accessories – Product overview	
	Page
Metre goods	626
Adapters	627
Ancillary lenses	628
Cutting tool	629



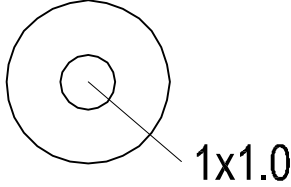
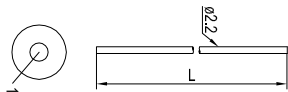

# Fibre-optic cables – accessories

Metre goods

K2L 1,0 POF simplex fibre-optic cable				Highlights		
				153-01034 <ul style="list-style-type: none"> <li>• Simplex plastic fibre-optic cable</li> <li>• Fibre length individually cuttable</li> </ul>		
Core fibre Ø (mm)	Fibre material	External diameter (mm)	Sheath material			
1 x 1.0	PMMA	2.2	Polyethylene (PE)	0.5	≤ 150	25

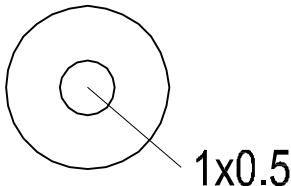
Part number	Article number
K2L 1,0 POF simplex	978-51680

K2L 0,5 POF simplex fibre-optic cable				Highlights		
				153-01035 <ul style="list-style-type: none"> <li>• Simplex plastic fibre-optic cable</li> <li>• Fibre length individually cuttable</li> </ul>		
Core fibre Ø (mm)	Fibre material	External diameter (mm)	Sheath material			
1 x 0.5	PMMA	1.0	Polyethylene (PE)	0.5	≤ 180	15

Part number	Article number
K2L 0,5 simplex	978-51688

Metre goods, adapters

K2R 1,0 POF duplex fibre-optic cable				Highlights		
				<ul style="list-style-type: none"> <li>• Duplex plastic fibre-optic cable</li> <li>• Fibre length individually cuttable</li> </ul>		
Core fibre Ø (mm)	Fibre material	External diameter (mm)	Sheath material	Numerical aperture	Damping at 650 nm (dB/km)	Fibre bending radius (mm)
2 x 1.0	PMMA	2 x 2.0	Polyethylene (PE)	0.46	≤ 150	25

Part number	Article number
K2R 1.0 POF duplex	979-51694

LMS 1,0-S2,2	Highlights
	<ul style="list-style-type: none"> <li>• Connection adapter (1.0 / 2.2 mm) for connecting fibres with external diameter of 1.0 mm to FL 20/FL 70 sensors</li> </ul>

Part number	Article number
LMS1,0-S2,2	724-01000

LMS 1,3-S2,2	Highlights
	<ul style="list-style-type: none"> <li>• Connection adapter (1.3 / 2.2 mm) for connecting fibres with external diameter of 1.3 mm to FL 20/FL 70 sensors</li> </ul>

Part number	Article number
LMS1,3-S2,2	724-01001

# Fibre-optic cables – accessories

## Ancillary lenses

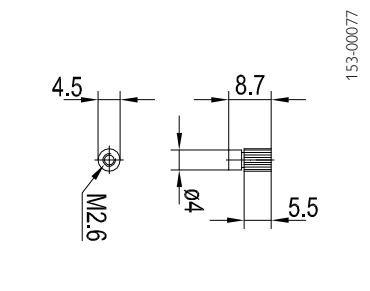
33 LVL 2,2		<b>Highlights</b>
		<ul style="list-style-type: none"> <li>• Ancillary lens for plastic fibres (pair)</li> <li>• For increasing the range of photoelectric sensors and reducing the aperture angle</li> <li>• Suitable for fibres with an external diameter of 2.2 mm or M2.6 sleeve</li> <li>• Right-angle light exit</li> </ul>

Part number	Article number
33 LVL 2,2	722-50775

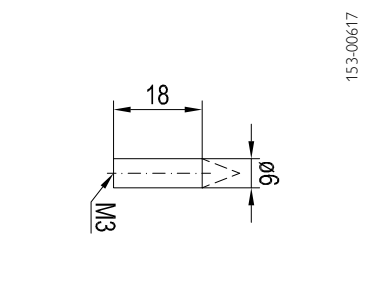
LVLF6-M3		<b>Highlights</b>
		<ul style="list-style-type: none"> <li>• Ancillary lens for fibre-optic cables (single lens)</li> <li>• For increasing the range of photoelectric sensors, reducing the aperture angle, or focusing the operating distance</li> <li>• Can be used with collar bushings with an M3 external thread</li> </ul>

Part number	Article number
LVLF6-M3	722-01003

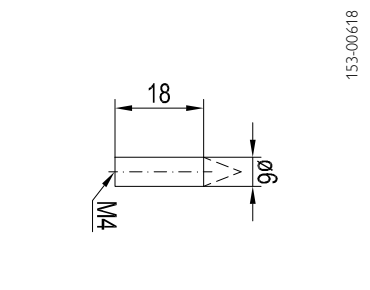
LVLF6-M4		<b>Highlights</b>
		<ul style="list-style-type: none"> <li>• Ancillary lens for fibre-optic cables (single lens)</li> <li>• For increasing the range of photoelectric sensors, reducing the aperture angle, or focusing the operating distance</li> <li>• Can be used with collar bushings with an M4 external thread</li> </ul>

Part number	Article number
LVLF6-M4	722-01004

## Ancillary lenses, cutting tool

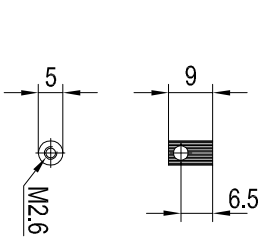
33 LVL 2,2-90°		Highlights
		<ul style="list-style-type: none"> <li>• Deflection prism: 90° for plastic fibres (pair)</li> <li>• Suitable for fibres with an external diameter of 2.2 mm or M2.6 sleeve</li> <li>• Straight light exit</li> </ul>

Part number	Article number
33 LVL 2,2-90 Grad	722-50776

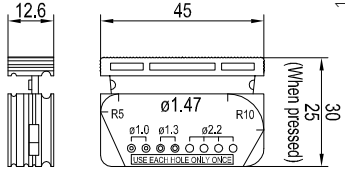
Cutting/bending tool		Highlights
		<ul style="list-style-type: none"> <li>• Combination tool for cutting and bending fibre-optic cables and fibre-optic cables with bendable tips</li> </ul>

Part number	Article number
Cutting tool	724-50799